

EUROPEAN ASSESSMENT DOCUMENT

EAD 020029-00-1102

April 2017

INTERNAL PEDESTRIAN FIRE RESISTING AND/OR SMOKE CONTROL SINGLE OR DOUBLE LEAF DOORSETS MADE OF STEEL

The reference title and language for this EAD is English. The applicable rules of copyright refer to the document elaborated in and published by EOTA.

This European Assessment Document (EAD) has been developed taking into account up-to-date technical and scientific knowledge at the time of issue and is published in accordance with the relevant provisions of Regulation No (EU) 305/2011 as a basis for the preparation and issuing of European Technical Assessments (ETA).

Contents

1	Scope of the EAD	4
1.1	Description of the construction product	4
1.2	Information on the intended use(s) of the construction product	4
1.2.1	Intended use(s).....	4
1.2.2	Working life/Durability.....	4
2	Essential characteristics and relevant assessment methods and criteria	6
2.1	Essential characteristics of the product	6
2.2	Methods and criteria for assessing the performance of the product in relation to essential characteristics of the product	6
2.2.1	Reaction to fire of components	6
2.2.2	Resistance to fire.....	7
2.2.3	Smoke control.....	7
2.2.4	Self-closing	7
2.2.5	Ability to release	7
2.2.6	Durability of the ability to release	7
2.2.7	Durability of self-closing against degradation (cycling testing)	7
2.2.8	Durability of self-closing against ageing (corrosion).....	7
2.2.9	Impact resistance	8
2.2.10	Strength requirements.....	8
2.2.11	Direct airborne sound insulation index (only for uses where acoustic performances is required)	8
3	Assessment and verification of constancy of performance	9
3.1	System of assessment and verification of constancy of performance to be applied	9
3.2	Tasks of the manufacturer	9
3.3	Tasks of the notified body	10
3.3.1	Initial inspection of factory and of FPC.....	10
3.3.2	Continuous surveillance of FPC.....	10
4	Reference documents	12
	Annex A - Extended application fire resistance	13
	Annex B - Extended application smoke control	13
	Annex C - Extended application permanent function	13

1 SCOPE OF THE EAD

1.1 Description of the construction product

Internal pedestrian fire resisting and/or smoke control single or double leaf doorsets are the subject of this EAD.

The products involve those which are used manually, opening and self-closing under the usual operating mode. They can also be kept open temporarily for usage purposes but close in the event of fire, smoke or malfunction or through manual release.

The fire resisting and/or smoke control doorsets shall be designed:

- using steel and stainless steel plates featuring fire-resistant inlays
- with building hardware,
- with or without any side panel(s), flush over panel(s) and/or transom panel(s) (with or without glazing) and contained within a single perimeter frame for inclusion in a single aperture,
- with or without any vision panel(s) in the door leaf or leave(s),
- with seals (e.g. for smoke control, fire resistance, draught or acoustic),
- with a three-sided permanently elastic seal (sealing tightly).

Fire resisting and/or smoke control doorsets can also be installed at levels other than the floor level (i.e. at increased heights) provided that the relevant test certificates exist. The fire door in the area of the frame of the leaf/the leaves shall be designed with a four-sided permanently elastic seal to prevent smoke from penetrating. The lower edge of the leaf/the leaves and the frame shall be designed like the upper edge. A permanently elastic middle rebate seal shall be installed additionally in the event of double leaf fire doors.

The product is not fully covered by harmonised technical specification EN 16034.

Concerning product packaging, transport, storage, maintenance, replacement and repair it is the responsibility of the manufacturer to undertake the appropriate measures and to advise his clients on the transport, storage, maintenance, replacement and repair of the product as he considers necessary.

It is assumed that the product will be installed according to the manufacturer's instructions or (in absence of such instructions) according to the usual practice of the building professionals.

Relevant manufacturer's stipulations having influence on the performance of the product covered by this European Assessment Document shall be considered for determining the performance and be specified in the ETA.

1.2 Information on the intended use(s) of the construction product

1.2.1 Intended use(s)

Fire resisting and/or smoke control doorsets are used internally as closures or for escape routes.

1.2.2 Working life/Durability

The assessment methods included or referred to in this EAD have been written based on the manufacturer's request to take into account a working life of the fire- and/or smoke resisting doors for the intended use of 15 years when installed in the works (provided that the fire resisting and/or smoke control doorsets has been appropriately installed (see 1.1)) These provisions are based on the current state of the art and the available knowledge and experience.

When assessing the product, the intended use as foreseen by the manufacturer shall be taken into account. Under normal use conditions, the real working life may be considerably longer without major degradation affecting the basic requirements for works¹.

The indications given as to the working life of the construction product cannot be interpreted as a guarantee neither given by the product manufacturer or his representative nor by EOTA when drafting this EAD nor by the Technical Assessment Body issuing an ETA based on this EAD, but are regarded only as a means for expressing the expected economically reasonable working life of the product.

¹ The real working life of a product incorporated in a specific works depends on the environmental conditions to which that works is subject, as well as on the particular conditions of the design, execution, use and maintenance of that works. Therefore, it cannot be excluded that in certain cases the real working life of the product is shorter than referred to above.

2 ESSENTIAL CHARACTERISTICS AND RELEVANT ASSESSMENT METHODS AND CRITERIA

2.1 Essential characteristics of the product

Table 1 shows how the performance of fire resisting and/or smoke control doorsets is assessed in relation to the essential characteristics.

Table 1 Essential characteristics of the product and methods and criteria for assessing the performance of the product in relation to those essential characteristics

No	Essential characteristic	Assessment method	Type of expression of product performance (level, class, description)
Basic Works Requirement 2: Safety in case of fire			
1	Reaction to fire of components	2.2.1	Class
2	Resistance to fire	2.2.2	Class
3	Smoke control	2.2.3	Class
Basic Works Requirement 4: Safety and accessibility in use			
4	Self-closing	2.2.4	Class
5	Ability to release	2.2.5	Declaration
6	Durability of the ability to release	2.2.6	Declaration
7	Durability of self-closing against degradation (cycling testing)	2.2.7	Class
8	Durability of self-closing against ageing (corrosion)	2.2.8	Declaration
9	Impact resistance	2.2.9	Class
10	Strength requirements	2.2.10	Class
Basic Works Requirement 5: Protection against noise			
11	Direct airborne sound insulation index	2.2.11	Grade

2.2 Methods and criteria for assessing the performance of the product in relation to essential characteristics of the product

The products to be assessed shall be characterised in accordance with available specifications.

This EAD contains provisions on how to declare certain performance characteristics. These provisions only apply if the manufacturer wishes to declare a performance for the relevant product characteristic.

2.2.1 Reaction to fire of components

Reaction to fire is the response of the doorset components to a fire to which they are exposed under specified conditions.

The reaction to fire of components shall be classified in accordance with EN 13501-1. Only test methods relevant for the class the manufacturer wants to prove for his product are relevant.

The materials to be considered belonging to class A1 without test are listed in the EC Decision 96/603/EC (as amended).

The relevant components that can be submitted are:

- door leaf and frame (steel and aluminium);
- infill (e.g. panels) or non-combustible material (mineral wool);
- sealing and gasket between infill and profile (standard flammable material).

Hardware components and gasket between frame and door leaf are not a relevant component due to negligible influence for reaction to fire performance (compression of the seal and overlapping of the rebate).

Components covered by their own product standard (e.g. glass products) do not need to be re-tested.

2.2.2 Resistance to fire

The fire resisting and/or smoke control doorsets shall be tested, using the test method relevant for the corresponding fire resistance class in accordance with EN 1634-1 in accordance with EN 16034 (chapter 4.1 and 5.1) plus Annex A of this EAD. They shall be classified according to EN 13501-2.

2.2.3 Smoke control

The fire resisting and/or smoke control doorsets shall be tested, using the test method relevant for the corresponding smoke control class in accordance with EN 1634-3 in accordance with EN 16034 (chapter 4.2 and 5.2) plus Annex B of this EAD and results shall be classified in accordance with EN 13501-2.

2.2.4 Self-closing

Self-closing is the ability of an open doorset to close fully into its frame and shall be tested in accordance with EN 16034 (chapter 4.4 and A.2.2). Results shall be classified in accordance with EN 13501-2.

2.2.5 Ability to release

The ability to release test shall be carried out on one sample which is submitted to fire resistance testing in accordance with EN 1634-1 or smoke control testing in accordance with EN 1634-3.

In order to release the fire resisting and/or smoke control doorsets and enable the reliable closing of a doorset in the event of fire and/or smoke or failure of the power supply, the hold-open device shall be tested in accordance with EN 16034 (chapter 4.3 and 5.3) and test results shall be expressed as “released”.

2.2.6 Durability of the ability to release

The durability of the ability to release is verified in accordance with EN 16034 (chapter 5.4.1). The result shall be expressed as “release maintained”.

2.2.7 Durability of self-closing against degradation (cycling testing)

The test methods for cycling testing are given in EN 1191 in accordance with EN 16034 (chapter 4.5.2.1 and 5.4.2) plus Annex C of this EAD.

2.2.8 Durability of self-closing against ageing (corrosion)

The durability of self-closing is considered to be achieved if the building hardware used in the doorset complies with the relevant clauses of the building hardware product standards as listed in EN 16034 (chapter 4.5.2.2).

The durability of self-closing against ageing (corrosion) of the doorset shall be expressed as “achieved”.

2.2.9 Impact resistance

Impact resistance of glazed doors with injury risk is the ability of a doorset to keep in place glazed parts.

Where safety glass is included, the following standards apply depending to the type of glass: EN 14449, EN 12150-2 or EN 14179-2. The results shall be expressed by the classes provided in EN 12600 for safe breaking (fracture behaviour).

The test shall be carried out and expressed in accordance with EN 13049. For some uses, the test shall be carried out from both sides.

2.2.10 Strength requirements

Fire resisting and/or smoke control doorsets shall be tested in accordance with EN 947, EN 948, EN 949 and EN 950 and test results shall be classified in accordance with EN 1192.

2.2.11 Direct airborne sound insulation index (only for uses where acoustic performances is required)

Direct airborne sound insulation is the ability of fire resisting and/or smoke control doorsets to insulate against direct airborne noise.

The acoustic performance of the doorset, the weighted sound reduction index and the spectrum adaptation terms R_w (C; C_{tr}) of operable fire resisting and/or smoke control doorsets shall be determined by test in accordance with EN ISO 10140-1 and 2 (reference method) and given in accordance with EN ISO 717-1.

3 ASSESSMENT AND VERIFICATION OF CONSTANCY OF PERFORMANCE

3.1 System of assessment and verification of constancy of performance to be applied

For the products covered by this EAD the applicable European legal act is: Decision 1999/0093/EU.

The system is: 1.

3.2 Tasks of the manufacturer

Acc. to EN 16034 chapter 6.3 the manufacturer has to establish, document and maintain an FPC system to ensure that the products placed on the market comply with the declared performance of the essential characteristics.

Furthermore, in this regard concerning the selection of test samples during the factory production control separate tests are required in following cases:

- significant components (which can affect its performance to the standard) are of different design or material,
- devices have different numbers of linkages,
- the model has been modified.

Please note that prototype samples are acceptable, if made from production tooling and using production assembly equipment is used.

The cornerstones of the actions to be undertaken by the manufacturer of the product in the procedure of assessment and verification of constancy of performance are laid down in Table 2.

Table 2 Control plan for the manufacturer; cornerstones

No	Subject/type of control (product, raw/constituent material, component - indicating characteristic concerned)	Test or control method	Criteria, if any	Minimum number of samples	Minimum frequency of control
Factory production control (FPC) [including testing of samples taken at the factory in accordance with a prescribed test plan]					
1	Incoming material/components	DoP / Manufac- turer's declaration	Manufactu rer's Control Plan	1	Every delivery
2	Reaction to fire Components not covered by a harmo- nised specification classified class E-B as per EN 13501-1	Manufac- turer's method	Manufactu rer's Control Plan	1	Every day/delivery
	Reaction to fire Components not covered by a harmo- nised specification classified class A1, A2 as per EN 13501-1	EN ISO 1182 and EN ISO 1716	Either loss on ignition or calorific potential	1	Every day/delivery
3	Parameters related to essential characteristic of Table 1 relevant for the intended use which are declared	EN 16034 chapter 6.3	compliance with EN 16034 chapter 6.3	1	Every delivery

No	Subject/type of control (product, raw/constituent material, component - indicating characteristic concerned)	Test or control method	Criteria, if any	Minimum number of samples	Minimum frequency of control
4	The manufacturer shall carry out: - factory production control - further testing of samples taken at the manufacturing plant by the manufacturer in accordance with the prescribed test plan. Essential characteristic of Table 1 relevant for the intended use which are declared	EN 16034 chapter 6.2	compliance with EN 16034 chapter 6.2	1	- at the beginning of a production series - at large production series → every day of production - at small series and single-unit production → every 30 th product

3.3 Tasks of the notified body

3.3.1 Initial inspection of factory and of FPC

Initial inspection of factory and of FPC shall be carried out when the production process has been finalized and in operation. The factory and FPC documentation shall be assessed to verify that the requirements are fulfilled - in accordance with EN 16034 chapter 6.3.4.

3.3.2 Continuous surveillance of FPC

Surveillance of the FPC shall be undertaken once per year - in accordance with EN 16034 chapter 6.3.5.

The notified product certification body shall decide on the issuing, restriction, suspension or withdrawal of the certificate of constancy of performance of the construction product on the basis of the outcome of the following assessments and verifications carried out by that body.

The cornerstones of the actions to be undertaken by the notified body of the product in the course of assessment and verification of constancy of performance are laid down in Table 3.

Table 3 Control plan for the notified body; cornerstones

No	Subject/type of control (product, raw/constituent material, component - indicating characteristic concerned)	Test or control method	Criteria, if any	Minimum number of samples	Minimum frequency of control
Initial inspection of the manufacturing plant and of factory production control					
1	Initial inspection of manufacturing plant and of FPC	Parameters related to essential characteristics of Table 1, relevant for the intended use which are declared, namely: Resistance to fire E, I Smoke leakage S Ability to release (only for the related hardware) Self-closing C Documentation of the FPC.	EN 16034 chapter 6.3.4	3	when starting the production or a new product line

No	Subject/type of control (product, raw/constituent material, component - indicating characteristic concerned)	Test or control method	Criteria, if any	Minimum number of samples	Minimum frequency of control
Continuous surveillance, assessment and evaluation of factory production control					
2	Continuous surveillance, assessment and evaluation of FPC	Parameters related to essential characteristics of Table 1, relevant for the intended use which are declared, namely: Resistance to fire Smoke control Ability to release Self-closing Documentation of the FPC.	EN 16034 chapter 6.3.5		once a year

4 REFERENCE DOCUMENTS

As far as no edition date is given in the list of standards thereafter, the standard in its current version at the time of issuing the European Technical Assessment is of relevance.

EN 16034	Pedestrian doorsets, industrial, commercial, garage doors and openable windows - Product standard, performance characteristics - Fire resisting and/or smoke control characteristics
EN 15269-2	Extended application of test results for fire resistance and/or smoke control for door, shutter and openable window assemblies, including their elements of building hardware - Part 2: Fire resistance of hinged and pivoted steel doorsets
EN 15269-20	Extended application of test results for fire resistance and/or smoke control for door, shutter and openable window assemblies, including their elements of building hardware - Part 20: Smoke control for hinged and pivoted steel, timber and metal framed glazed doorsets
prEN 17020-1	Extended application of test results on durability of self-closing for fire resistance and/or smoke control doorsets and openable windows - Part 1: Durability of self-closing of hinged and pivoted steel doorsets
prEN 14351-2	Windows and doors - Product standard, performance - Part 2: Internal pedestrian doorsets
EN 1634-1	Fire resistance and smoke control tests for door, shutter and openable window assemblies and elements of building hardware - Part 1: Fire resistance tests for doors, shutters and openable windows
EN 1634-3	Fire resistance tests for door and shutter assemblies - Part 3: Smoke control doors and shutters
EN 1191	Windows and doors - Resistance to repeated opening and closing - Test method
EN 12150-2	Glass in building - Thermally toughened soda lime silicate safety glass - Part 2: Evaluation of conformity
EN 12600	Glass in building - Pendulum test - Impact test method and classification for flat glass
EN 13049	Windows - Soft and heavy body impact - Test method, safety requirements and classification
EN 14179-2	Glass in building - Heat soaked thermally toughened soda lime silicate safety glass - Part 2: Evaluation of conformity/product standard
EN 14449	Glass in building - Laminated glass and laminated safety glass - Evaluation of conformity/product standard
EN ISO 717-1	Acoustics - Rating of sound insulation in buildings and of building elements - Part 1: Airborne sound insulation (ISO 717-1)
EN ISO 10140-1	Acoustics - Laboratory measurement of sound insulation of building elements - Part 1: Application rules for specific products (ISO 10140-1)
EN 947	Hinged or pivoted doors - Determination of the resistance to vertical load
EN 948	Hinged or pivoted doors - Determination of the resistance to static torsion
EN 949	Windows and curtain walling, doors, blinds and shutters - Determination of the resistance to soft and heavy body impact for doors
EN 950	Door leaves - Determination of the resistance to hard body impact
EN 1192	Doors - Classification of strength requirements
EN 13501-1	Fire classification of construction products and building elements - Part 1: Classification using data from reaction to fire tests
EN 13501-2	Fire classification of construction products and building elements - Part 2: Classification using data from fire resistance tests, excluding ventilation services

ANNEX A - Extended application fire resistance

ANNEX B - Extended application smoke control

ANNEX C - Extended application permanent function

Annex A – Extended application fire resistance

1. General

Annex A covers single and double leaf, hinged and pivoted, steel based doorsets and prescribes the methodology for extending the application of test results obtained from fire resistance test(s) conducted in accordance with EN 1634-1.

Before there can be any consideration for extended application, the doorset will need to have been tested in accordance with EN 1634-1 to achieve a test result which could generate a classification in accordance with EN 13501-2 at least equal to the classification subsequently required from extended application considerations.

Subject to the completion of the appropriate test or tests, the extended application may cover all or some of the following examples:

- integrity/insulation (EI₁ or EI₂) classification;
- door leaf;
- wall/ceiling fixed elements (frame/suspension system);
- glazing for door leaf, side, transom and flush over panels;
- items of building hardware;
- decorative finishes;
- intumescent, smoke, draught or acoustic seals;
- alternative supporting construction(s).

Extended application are possible provided that the standard tests have been carried out on single and double leaf fire doorsets (open outwards and inwards) using the maximum dimensions.

2. Determination of the field of extended application

Before there can be any consideration for extended application, a representative doorset shall have been tested and classified in accordance with EN1634-1 and EN 13501-2 respectively in order to establish a classification for the doorset.

A review of the doorset construction parameters can indicate that one or more characteristics may be improved by a particular parameter variation. All evaluations shall be made on the basis of retaining the classifications obtainable from testing to EN 1634-1, including those lower than the test duration. However, this shall never lead to an increased classification for any specific parameter beyond that achieved during any one test unless specifically identified in the relevant Construction Parameter Variation tables.

If, when following the extended application procedure, any part of the classified product cannot be covered by the extended application rules, that part shall be omitted from the subsequent extended application report and classification report.

Identify the variations from the original test specimen(s) which are required to be covered by an extended application report.

Locate the variations in the appropriate parameter variation by reference to columns (1) and (2) of table A.

Review the type of classification to be retained from column (3) and establish from the contents of column (4) whether any extended application is available beyond the direct application rules in EN 1634-1 without the need for further testing.

Where this is deemed possible, it can be recorded in the extended application report together with any appropriate restrictions and the stated rules from column (4) of table A.

Where the variations required can only be achieved from additional testing, the additional test can be made on a similar specimen type i.e. a doorset of the same or more onerous configuration where the leaf construction is fundamentally the same as tested. Alternatively, column (5) identifies an option for alternative testing and relevant test parameters.

3. Procedure for maximum field of extended application

It is possible to provide an extended field of application from a single test. However, if a manufacturer intends to produce a range of doors incorporating single doors and also double doors, with or without side, transom or flush over panels, with or without glazing, with or without louvres or ventilation grilles, with alternative elements of building hardware, etc., it is recommended that careful consideration be given to the complete range of doorset designs and options in order to minimise the testing required before testing commences.

Establish all the parameter variations which are required to be part of the product range.

Determine which are the most important specification requirements and incorporate as many as possible into the specimen(s) for the first tests in the series.

Conduct the first fire resistance test or a series of tests and then establish which of the original desired parameter variations have not been covered by the fire resistance tests, including direct application possibilities.

Identify these parameter variations in table A and establish if any extended application is possible without further testing.

Record this for the extended application report together with any restrictions and rules given in column (4) in table A.

Evaluate which, if any, of the desired parameter variations have not been covered by the field of direct application or the initial field of extended application derived from chapter 3.

Determine if the product range is to include only single leaf doorsets or if the range is to also include double leaf configurations. Where only single doorsets are to be part of the product range, the outstanding construction parameter variations shall only be incorporated into specimens for the single leaf doorsets. Where single leaf and double leaf doorsets are to be included in the product range, the outstanding construction parameter variations for the extended application of single leaf doorsets may be incorporated into either repeated single leaf doorset tests or, in the weakest option, as defined in column (5) of the table in table A, double leaf doorset configurations.

Select the required outstanding parameter variations from column (1) and column (2) of table A and observe from column (5) in table A which are the most appropriate, weakest specimen options for further testing.

If the complete selection of required parameter variations has not been covered by the tests as listed above, then an appropriate test or tests may be repeated with the additional product variations incorporated.

4. Analysis of test results

In order to maximise the extended field of application, it is important that the test reports shall record details of any premature integrity and/or insulation failure also record details of any distortion to evaluate low, medium and high distortion (see table A).

Where a series of tests have been conducted, the field of extended application shall be based on the lowest performance achieved from the complete series of tests unless premature failure has been attributed to one or more specific construction parameter variations.

Where it has been possible to identify specific parameter failures, the extended application for all other construction parameter variations can be based on the performance achieved after isolating the premature failure(s).

Prepare an extended application report in accordance with the requirements of EN 15269-1:2010, Clause 6 based on the results of evaluations in accordance with the above.

The classification report shall be determined from the results of the extended application report and presented in accordance with EN 13501-2.

5. Construction parameter variations

Table A is designed to be used by experts competent in the field of fire resistance testing of hinged and pivoted steel doorsets.

The table shall only be used to assess a field of extended application when at least one positive fire resistance test to EN 1634-1 has generated a classification according to EN 13501-2.

The first two columns identify possible variations to the construction details of the specimen tested.

The influence of variation on performance characteristic is identified from column (3) as integrity, insulation or radiation (E, I or W respectively). For some parameters, it is necessary to evaluate whether the specimen displayed a high, medium or low level of distortion during the test. Where this is the case, the following levels shall be used to establish high, medium and low distortion doorsets as measured using the maximum relative movement at any position between the edge of the door leaf and door frame or between the meeting edges of door leaves or the relative movement of the framing members for panelled systems. The measurements shall be taken from the start of the test at any time during the complete required classification period. The deflections shall be measured at the positions given in EN 1634-1:

- low < 40 % of effective rebate depth;
- medium ≥ 40 % and ≤ 85 % of effective rebate depth;
- high > 85 % of effective rebate depth.

The effect of the change in each parameter is evaluated for each characteristic in column (3) under E for effects on integrity, I for effects on insulation (whether an I₁ or I₂) and W for the effects on radiation.

These evaluations lead to the judgement of the possibility of extending the field of application, the results of which are given in column (4). In certain cases in column (4), it is a requirement to achieve Category B, the requirements for which are given in EN 1634-1.

Where additional tests are deemed to be necessary, the type of specimen approved for incorporation of the changed parameter is defined in column (5). Where it is possible to use information from tests performed on one configuration for evidence on a different configuration, this allowance has been made in order to reduce the overall number of tests required for extended application evaluation e.g. single action doorsets to double action doorsets.

Where an additional test is required in column (5), the test is a full scale test with the specimen opening outwards (away from the furnace) unless otherwise specified.

In order to maximise the possible field of application from a minimum number of tests, the parameter changes have been spread over a series of test specimens. The recommended tests for each parameter is dependant upon the classification required and the preferred direction of testing as indicated in column (5).

Where more than a single parameter variation is required, the influence on other variations shall also be taken into account.

Table A - Construction parameter variations

Key to symbols in column (3) (which is informative only)

- > - higher performance anticipated
- < - lower performance anticipated
- = - no significant change in performance anticipated
- ≥ - equal or higher performance anticipated
- ≤ - equal or lower performance anticipated
- >=< - the influence on performance could be worse, equal or better hence variations not possible unless specific, limited conditions are identified

Construction Parameter (1)	Variation (2)	Influence of variation on performance characteristic (3)			Possibility of extension (4)	Additional Evidence Required (5)
		E	I	W		
A Door leaf						
In certain cases, the rules given in Section A are also appropriate to side, transom and flush over panels or the door frame. Where this is the case, it is clearly indicated at the beginning of the relevant section. For double leaf doorsets, both leaves shall be of the same basic construction.						
A.1 General						
A.1.1 Number of leaves - see Figure A.1 Only applicable to doorsets tested without transom and/or flush over panels - see Annex B	Single leaf from double leaf test	≤	≥	≥	Not possible without an additional test	Additional test single leaf doorset
A.1.2 Number of leaves Only applicable to doorsets tested without transom and/or flush over panels - see Annex B	Double leaf from single leaf test	<	≤	≤	Not possible without additional test (s)	Additional test (s) double leaf doorset (open outwards and inwards for EI doors, open outwards for E or W doors)
A.1.5 Intumescent seals between frame and door leaf/leaves - see Figure A.3	Location towards the frame rebate	>=<	>=<	>=<	Not possible without an additional test	Additional test single leaf or double leaf doorset
A.1.6 Intumescent seals between frame and door leaf/leaves – see Figure A.4	Location away from the frame rebate	>=<	>=<	>=<	Not possible without an additional test	Additional test single leaf or double leaf doorset
A.1.7 Intumescent seals between meeting edges of the door leaves	Location	>=<	>=<	>=<	Not possible without additional test (s)	Additional test (s) double leaf doorset (open outwards and inwards for EI doors, open outwards for E or W doors)

Construction Parameter	Variation	Influence of variation on performance characteristic			Possibility of extension	Additional Evidence Required
(1)	(2)	(3)			(4)	(5)
		E	I	W		
A.1.8 Non-intumescent seals between frame and door leaf/leaves (draught/smoke/acoustic etc.) – Euroclass A1, e.g. ceramic products (fitted in leaf or frame) - see Figure A.5	Location	=	=	=	Any movement possible providing no modifications of the construction are required Otherwise not possible without an additional test	Additional test single or double leaf doorset, if the seal is positioned between the meeting edges of the door leaves the additional test shall be a double leaf doorset
A.1.9 Non-intumescent seals between meeting edges of the door leaves (draught/smoke/acoustic etc.) - Euroclass A1, e.g. ceramic products	Location	>=/<	>=/<	>=/<	No movement possible without an additional test	Additional test double leaf doorset
A.1.10 Non-intumescent seals between door leaves and/or frames (draught/smoke/acoustic etc.) – < Euroclass A1 (fitted in leaf or frame) - see Figure A.6	Location	>=/<	>=/<	>=/<	No movement possible without an additional test	Additional test single or double leaf doorset, if the seal is positioned between the meeting edges of the door leaves the additional test shall be a double leaf doorset
A.1.11 Non-intumescent seals between door leaves and/or frames (draught/smoke/acoustic etc.) - Euroclass A1, e.g. ceramic products (fitted in leaf or frame) - see Figure A.7	Add	=	=	=	Possible for doors without intumescent seals and providing the gap between door leaf and door frame is not increased Otherwise not possible without an additional test	Additional test single or double leaf doorset, if the seal is positioned between the meeting edges of the door leaves the additional test shall be a double leaf doorset
A.1.12 Non-intumescent seals between door leaves and/or frames (draught/smoke/acoustic etc.) - Euroclass A1, e.g. ceramic products (fitted in leaf or frame) - see Figure A.8	Remove	≤	≤	≤	Not possible without an additional test	Additional test single or double leaf doorset, if the seal is positioned between the meeting edges of the door leaves the additional test shall be a double leaf doorset
A.1.14 Non-intumescent seals between door leaves and/or frames (draught/smoke/acoustic etc. – < Euroclass A1 (fitted in leaf or frame) - see Figure A.10	Remove	>=/<	>=/<	=	Not possible without an additional test	Additional test single or double leaf doorset, if the seal is positioned between the meeting edges of the door leaves the additional test shall be a double leaf doorset

Construction Parameter	Variation	Influence of variation on performance characteristic			Possibility of extension	Additional Evidence Required																
(1)	(2)	(3)			(4)	(5)																
		E	I	W																		
A.1.20 Rebate (door leaves to frames) - see Figure A.14 a)	Add	≥	≤	≥	EI Not possible without an additional test unless the original test had additional thermocouples positioned 100 mm and/or 25 mm from the edge of the notional rebate (i.e. 100-x) where x means the width of the added rebate and dimension y (overlap) shall not be decreased by a maximum of three times the steel thickness of the door leaf	Additional test single or double leaf doorset Additional test single leaf doorset (open inwards)																
A.1.21 Rebate (meeting edges) - see Figure A.14 b)	Add (one rebate)	≥	≥	≥	Possible if the doorset included one rebate and the added rebate is of the same design/material as that tested Otherwise not possible without an additional test	Additional test double leaf doorset (added rebate away from the fire)																
A.1.22 Rebate (door leaves to frames) - see Figure A.15	Remove	≤	≤	≤	Not possible without an additional test	Additional test single or double leaf doorset (open inwards)																
A.1.23 Rebate (meeting edges)	Remove	≤	≤	≤	Not possible without an additional test	Additional test double leaf doorset (open inwards)																
A.1.24 Latched condition for single and double leaf doorsets	Change in latching condition	>><<	=	=	Possible in line with the following relationship: <table border="1" data-bbox="1240 871 1787 1372"> <thead> <tr> <th></th> <th>Tested without a latch/lock</th> <th>Tested with a latch/lock but unlatched</th> <th>Tested with a latch/lock latched</th> </tr> </thead> <tbody> <tr> <td>Extension to: without a lock/latch</td> <td>-</td> <td>Possible</td> <td>Not possible</td> </tr> <tr> <td>Extension to: with lock/latch but unlocked/unlatched</td> <td>Not possible</td> <td>-</td> <td>Not possible</td> </tr> <tr> <td>Extension to: with a lock/latch, latched</td> <td>Not possible</td> <td>Possible</td> <td>-</td> </tr> </tbody> </table>		Tested without a latch/lock	Tested with a latch/lock but unlatched	Tested with a latch/lock latched	Extension to: without a lock/latch	-	Possible	Not possible	Extension to: with lock/latch but unlocked/unlatched	Not possible	-	Not possible	Extension to: with a lock/latch, latched	Not possible	Possible	-	Additional test to include the required latching condition
	Tested without a latch/lock	Tested with a latch/lock but unlatched	Tested with a latch/lock latched																			
Extension to: without a lock/latch	-	Possible	Not possible																			
Extension to: with lock/latch but unlocked/unlatched	Not possible	-	Not possible																			
Extension to: with a lock/latch, latched	Not possible	Possible	-																			

Construction Parameter	Variation	Influence of variation on performance characteristic			Possibility of extension	Additional Evidence Required
(1)	(2)	(3)			(4)	(5)
		E	I	W		
A.2 Size variations/single or multiple panel construction						
A.2.1 Size (area, width, height) all distortions	Decrease	≥	≤	≥	Possible in line with direct application or for EI doors Possible from the size tested down to the size of a second test specimen in the same design using direct application rules Otherwise not possible without an additional	For single leaf doorsets additional test largest single leaf or double leaf doorset , for double leaf doorsets additional test largest double leaf doorset (open outwards and inwards)
A.2.5 Thickness of the door leaf based on high distortion	Increase	>=/ <	≥	≥	Not possible without an additional test	Additional test single or double leaf doorset
based on medium distortion		>=/ <	≥	≥	Possible providing the same increase of thickness of core material by a maximum of 10 % Otherwise not possible without an additional test	Additional test single or double leaf doorset
based on low distortion		>=/ <	≥	≥	Possible providing the same increase of thickness of core material by a maximum of 25 % Otherwise not possible without an additional test	Additional test single or double leaf doorset
A.2.6 Thickness of the door leaf - all distortions	Decrease	>=/ <	≤	≤	EI Not possible without an additional test	Additional test single for single leaf doorsets or double leaf for double leaf doorsets
A.3. Materials and constructions						
A.3.1 Density of core material (organic or Euroclass A1) – all distortions	Increase	>=/ <	≥	≥	Possible by a maximum of 15 % (nominal value) of each core material of the door leaf above 15 % Not possible without an additional test	Additional test single or double leaf doorset (open outwards)
A.3.2 Density of core material (organic or Euroclass A1) – all distortions	Decrease	>=/ <	≤	≤	EI Not possible without an additional test	Additional test single or double leaf doorset (open inwards)
A.3.4 Thickness of core material - see Figure A.17	Decrease	>=/ <	≤	≤	EI Not possible without an additional test	Additional test single for single leaf doorsets or double leaf for double leaf doorsets

Construction Parameter	Variation	Influence of variation on performance characteristic			Possibility of extension	Additional Evidence Required
(1)	(2)	(3)			(4)	(5)
		E	I	W		
A.3.5 Pattern of core material - see Figure A.18	Increase number of pieces	>/=/<	≤	≤	EI Possible proportional to any size increase providing the original test specimen includes horizontal and/or vertical joint (s) between the core material pieces as appropriate Otherwise not possible without an additional test	Additional test single or double leaf doorset
A.3.6 Pattern of core material - see Figure A.19	Decrease number of pieces	≥	≥	≥	Possible	-
A.3.7 Number of layers of identical and/or different materials - see Figure A.20	Increase	>/=/<	>/=/<	>/=/<	Not possible without an additional test	Additional test single or double leaf doorset
A.3.10 Type of core material (single thickness or in combination of different layers)	Alternative composition	>/=/<	>/=/<	>/=/<	Not possible without an additional test	Additional test single or double leaf doorset
A.3.11 Amount of adhesive/m ² – organic based (< Euroclass A1)	Increase	≤	=	=	Not possible without an additional test	Additional test single or double leaf doorset
A.3.12 Amount of adhesive/m ² – organic based (< Euroclass A1)	Decrease	≤	≤	≤	Possible	-
A.3.13 Amount of adhesive/m ² – inorganic based (Euroclass A1)	Increase	=	=	=	Possible providing no intumescent content Otherwise not possible without an additional test	Additional test single or double leaf doorset
A.3.14 Amount of adhesive/m ² – inorganic based (Euroclass A1)	Decrease	≤	≤	≤	Not possible without an additional test	Additional test single or double leaf doorset
A.3.15 Type of adhesive	Change of manufacturer for identical composition	=	=	=	Possible for identical chemical composition Otherwise not possible without an additional test	Additional test single or double leaf doorset
A.3.16 Type of adhesive	Alternative composition	>/=/<	>/=/<	>/=/<	Not possible without an additional test	Additional test single or double leaf doorset
A.3.17 Metal armour sheet (internally mounted) - see Figure A.22 a)	Add	≤	≤	≤	Not possible without an additional test	Additional test single or double leaf doorset
A.3.18 Metal armour sheet (internally mounted) - see Figure A.22 b)	Remove	≤	≤	≤	Not possible without an additional test	Additional test single or double leaf doorset

Construction Parameter	Variation	Influence of variation on performance characteristic			Possibility of extension	Additional Evidence Required
(1)	(2)	(3)			(4)	(5)
		E	I	W		
A.3.19 Electronic security mesh - see Figure A.23 a)	Add	=	=	=	Possible for mesh thickness to a maximum of 1,0 mm with an inorganic coating – face fixed or internally mounted Otherwise not possible without an additional test Also not possible for organic coated mesh without additional test	Additional test single or double leaf doorset
A.3.20 Electronic security mesh - see Figure A.23 b)	Remove	=	=	=	Possible	-
A.3.23 Type of steel sheet	Mild to stainless	>=/<	>=/<	>=/<	Possible only for low and medium distortion latched door leaves providing that the material thickness shall not be increased but may be decreased up to a maximum of 20 % Otherwise not possible without an additional test	Additional test single or double leaf doorset
A.3.24 Type of steel sheet	Stainless to mild	>=/<	>=/<	>=/<	Possible only for latched door leaves providing that the material thickness shall not be decreased but may be increased up to a maximum of 25 % Otherwise not possible without an additional test	Additional test single or double leaf doorset
A.3.25 Cross-section dimension of stiffening elements - see Figure A.24 a)	Increase	≥	≤	≥	EI Not possible without an additional test	Additional test single or double leaf doorset
A.3.26 Cross-section dimension of stiffening elements - see Figure A.24 b)	Decrease	≤	=	=	Not possible without an additional test	Additional test single or double leaf doorset
A.3.27 Number of intermediate stiffening elements - see Figure A.25 a)	Increase	≥	≤	≤	EI Possible proportional to the increase of height or width of the panel, as appropriate, rounded to the nearest whole number of stiffeners Otherwise not possible without an additional test	Additional test single or double leaf doorset
A.3.28 Number of intermediate stiffening elements - see Figure A.25 b)	Decrease	≤	≥	≥	Possible proportional to the decrease of height or width of the panel, as appropriate, rounded to the nearest whole number of stiffeners Otherwise not possible without an additional test	Additional test single or double leaf doorset

Construction Parameter (1)	Variation (2)	Influence of variation on performance characteristic (3)			Possibility of extension (4)	Additional Evidence Required (5)
		E	I	W		
A.3.29 Stiffening elements - see Figure A.26	Location	>=/ <	=	=	Possible within a maximum of 10 % of original separating dimension Otherwise not possible without an additional test	Additional test single or double leaf doorset
A.3.30 Number of stiffening element fixing points - see Figure A.27 a)	Increase	≥	=	=	Possible	-
A.3.31 Number of stiffening element fixing points - see Figure A.27 b)	Decrease	≤	=	=	Possible if proportionately in line with a leaf size decrease Otherwise not possible without an additional test	Additional test single or double leaf doorset
A.3.32 Overlap dimension of leaf edge rebate (between leaf and frame) - see Figure A.28 a)	Increase	≥	≤	>=/ <	EI Possible providing the original test had additional thermocouples positioned 100mm or 25mm from the edge of the notional rebate Otherwise not possible without an additional test	Additional test single or double leaf doorset (open outwards)
A.3.33 Overlap dimension of panel edge rebate (meeting edges) - see Figure A.28 b)	Increase	≤	≥	>=/ <	EI Possible providing the original test had additional thermocouples positioned 100mm or 25mm from the edge of the notional rebate Otherwise not possible without an additional test	Additional test double leaf doorset
A.3.34 Overlap dimension of leaf edge rebate (between leaf and frame) - see Figure A.29 a)	Decrease	≤	≥	>=/ <	Not possible without an additional test	Additional test single or double leaf doorset
A.3.35 Overlap dimension of panel edge rebate (meeting edges) - see Figure A.29 b)	Decrease	≤	≥	>=/ <	Not possible without an additional test	Additional test double leaf doorset
A.3.36 Additional overlapping edge at the bottom of the door - see Figure A.30 a)	Add	≥	≤	>=/ <	EI Possible providing the tested overlapping edge at the top of the leaf is added at the bottom of the leaf and providing a fourth frame member is added Otherwise not possible without an additional test	Additional test single or double leaf doorset

Construction Parameter	Variation	Influence of variation on performance characteristic			Possibility of extension	Additional Evidence Required
(1)	(2)	(3)			(4)	(5)
		E	I	W		
A.3.37 Additional overlapping edge at the bottom of the door leaf - see Figure A.30 b)	Remove	≤	≥	>=/ <	Possible providing the gap between the bottom of the door leaf and the floor remains the same as the original test specimen Otherwise not possible without an additional test	Additional test single or double leaf doorset
A.3.38 Leaf edge detail (between leaf and frame and meeting edges) - see Figure A.31	Shape	=	=	=	Straight overlap may be changed to cranked overlap (but not vice versa) providing the overlap dimension and the gap between the leaf and the frame or the meeting edges are not changed; more significant modifications shall to be subjected to an additional test	Additional test single or double leaf doorset
A.3.39 Jointing/assembly technique (leaf edges, stiffening elements etc.) for leaf or frame - see Figure A.32	Alternative (welding/ riveting/screwing)	=	=	=	Possible to interchange only between welding, riveting and screwing, providing that the centre distances are not exceeded, fixings are made from the same materials and cross section dimension of the alternative (welds/rivets/screws) is not smaller Otherwise not possible without an additional test	Additional test single or double leaf doorset
A.3.40 Dimension of intumescent seals (leaf or frame fitted) - see Figure A.33 a)	Increase	>=/ <	>=/ <	>=/ <	Not possible without an additional test	Additional test single or double leaf doorset
A.3.41 Dimension of intumescent seals (leaf or frame fitted) - see Figure A.33 b)	Decrease	≤	≤	≤	Not possible without an additional test	Additional test single or double leaf doorset
A.3.42 Type of intumescent seals (leaf or frame fitted)	Change of supplier/manufacturer	>=/ <	>=/ <	>=/ <	Possible but only for identical composition Otherwise not possible without an additional test	Additional test single or double leaf doorset
A.3.43 Type of intumescent seals (leaf or frame fitted)	Alternative material	>=/ <	>=/ <	>=/ <	Not possible without an additional test	Additional test single or double leaf doorset
A.3.44 Dimension of draught/smoke seals (Euroclass A1); e.g. ceramic products (leaf or frame fitted) – see Figure A.34 a)	Increase	≥	=	=	Possible providing the gap between door leaf and door frame is not increased Otherwise not possible without an additional test	Additional test single or double leaf doorset
A.3.45 Dimension of draught/smoke seals (Euroclass A1); e.g. ceramic products (leaf or frame fitted) - see Figure A.34 b)	Decrease	≤	=	=	Not possible without an additional test	Additional test single or double leaf doorset

Construction Parameter	Variation	Influence of variation on performance characteristic			Possibility of extension	Additional Evidence Required
(1)	(2)	(3)			(4)	(5)
		E	I	W		
A.3.46 Dimension of draught/smoke seals (< Euroclass A1) - leaf or frame fitted – see Figure A.35 a)	Increase	≤	≤	≤	Possible up to a maximum of 30 % in any cross sectional dimension and up to a maximum of 20 % mass providing the same material and the same manufacturer and providing the gap between door leaf and frame is not increased Otherwise not possible without an additional test	Additional test single or double leaf doorset
A.3.47 Dimension of draught/smoke seals (< Euroclass A1) (leaf or frame fitted) - see Figure A.35 b)	Decrease	≥	≥	≥	Possible up to a maximum of 30 % in any cross sectional dimension providing the same material and the same manufacturer Otherwise not possible without an additional test	Additional test single or double leaf doorset
A.3.48 Type of draught/smoke seals (leaf or frame fitted)	Change of supplier/ manufacturer	>=/<	=	=	Possible for Euroclass A1 material or for identical chemical composition where known Otherwise not possible without an additional test	Additional test single or double leaf doorset
A.3.49 Type of draught/smoke seals (leaf or frame fitted)	Alternative material (changing to a equal or higher Euroclass)	=	=	=	Possible	-
A.3.50 Type of draught/smoke seals (leaf or frame fitted)	Alternative material (changing to a lower Euroclass)	≤	≤	≤	Not possible without an additional test	Additional test single or double leaf doorset
A.4. Decorative and/or protective finishes						
A.4.1 Paints without contribution to fire resistance (on leaf or frame)	Addition	=	=	=	Possible in line with direct application beyond the field of direct application rules Not possible without an additional test	Additional test single or double leaf doorset
A.4.2 Paints without contribution to fire resistance (on leaf or frame)	Interchange	=	=	=	Possible	-
A.4.3 Thickness of paints with positive contribution to fire resistance (on leaf or frame)	Increase	≥	≥	≥	Possible up to a maximum of 25 % in mass per m ² Otherwise not possible without an additional test	Additional test single or double leaf doorset
A.4.4 Thickness of paints with positive contribution to fire resistance (on leaf or frame)	Decrease	≤	≤	≤	Not possible without an additional test	Additional test single or double leaf doorset

Construction Parameter	Variation	Influence of variation on performance characteristic			Possibility of extension	Additional Evidence Required
(1)	(2)	(3)			(4)	(5)
		E	I	W		
A.4.5 Type of paints with positive contribution to fire resistance (on leaf or frame)	Change of supplier/manufacturer	>/=/<	>/=/<	=	Possible but only for identical composition Otherwise not possible without an additional test	Additional test single or double leaf doorset
A.4.6 Type of paints with positive contribution to fire resistance (on leaf or frame)	Alternative material	>/=/<	>/=/<	>/=/<	Not possible without an additional test	Additional test single or double leaf doorset
A.4.7 Decorative laminates on the face (on leaf or frame) - see Figure A.36	Add	>/=/<	≥	≥	Possible in line with direct application Otherwise not possible without additional test	Additional test single or double leaf doorset
A.4.8 Decorative laminates on the face (on leaf or frame) - see Figure A.37	Remove	≥	≤	≤	EI Not possible without an additional test	Additional test single or double leaf doorset
A.4.9 Decorative laminates on the edges (on leaf or frame) - see Figure A.38	Add	≤	≤	≤	Not possible without an additional test	Additional test single or double leaf doorset
A.4.10 Decorative laminates on meeting edges	Add	≤	≤	≤	Not possible without an additional test	Additional test double leaf doorset
A.4.11 Decorative laminates on the edges (on leaf or frame) - see Figure A.39	Remove	≥	=	=	Possible providing the gap dimension is retained between door leaf and frame Otherwise not possible without additional test	Additional test single or double leaf doorset
A.4.12 Types and thickness of decorative laminates on the face (on leaf or frame)	Change material content, increase, decrease	>/=/<	>/=/<	>/=/<	Possible in line with direct application beyond the field of direct application rules Not possible without an additional test	Additional test single or double leaf doorset
A.4.13 Types and thickness of decorative laminates on the edges (leaf to frame)	Change material content, increase, decrease	>/=/<	>/=/<	>/=/<	Not possible without an additional test	Additional test single or double leaf doorset
A.4.14 Types and thickness of decorative laminates on the meeting edges	Change material content, increase, decrease	>/=/<	>/=/<	>/=/<	Not possible without an additional test	Additional test double leaf doorset
A.4.15 Types of decorative laminates on the face/edges (on leaf or frame)	Colour, pattern	=	=	=	Possible in line with direct application Otherwise not possible without additional test	Additional test single or double leaf doorset

Construction Parameter	Variation	Influence of variation on performance characteristic			Possibility of extension	Additional Evidence Required
(1)	(2)	(3)			(4)	(5)
		E	I	W		
A.4.14 Protective elements – face fixed (kick plates/push plates/armour plates) - See Figure A.40	Add	>=/<	>=/<	>=/<	Possible for one piece up to 800 mm from the base of the leaf providing no thicker than 1,5 mm or limited to maximum two pieces per face at 250 mm in width or height (for E and EW doors the elements shall be Euroclass A1). For acceptable fixing methods see A4.16 Otherwise not possible without an additional test	Additional test single or double leaf doorse
A.4.15 Protective elements – face fixed (kick plates/push plates/armour plates)	Remove	>=/<	>=/<	>=/<	Not possible without an additional test	Additional test single or double leaf doorset
A.4.16 Attachment technique for elements added to doors	Selection (adhesive/rivet/screw)	=	=	=	EI Only selection of Euroclass A1 material for fixings possible and for EI doors providing no through connection All selections possible within the area where thermocouples shall be placed and providing no through connection Otherwise not possible without an additional test	Additional test single or double leaf doorset
A.4.17 Mouldings/profiles - see Figure A.41	Add	≤	=	≤	EI Possible only for mouldings/profiles which will not change the structural rigidity of the leaf and providing no break through to opposite face. Additionally for Otherwise not possible without an additional test	Additional test single or double leaf doorset
A.4.18 Mouldings/profiles - see Figure A.41	Remove	≥	≤	≤	EI Not possible without an additional test	Additional test single or double leaf doorset
B. Door Frame						
B.1. General <i>For intumescent/draught/smoke seals refer to sections A.1</i>						
B.1.1 Threshold/sill/frame member to bottom of door frame	Add	≥	≥	≥	Possible	-

Construction Parameter	Variation	Influence of variation on performance characteristic			Possibility of extension	Additional Evidence Required
(1)	(2)	(3)			(4)	(5)
		E	I	W		
B.1.2 Threshold/sill/frame member to bottom of door frame	Remove	≤	≤	≤	Possible providing the gap between the bottom of the door leaf and the floor level remains the same as the original test specimen Otherwise not possible without an additional test	Additional test single or double leaf doorset
B.2. Materials and constructions						
B.2.1 Overall dimensions and shape - see Figure A.43	Increase	≥	≥	≥	Possible providing that the cross section detail at the overlap/rebate position (shown in bold in Figure A.43) is retained or the overlap dimension is increased Otherwise not possible without an additional test	Additional test single or double leaf doorset
B.2.2 Overall dimensions and shape - see Figure A.44	Decrease	≤	≤	≤	Not possible without an additional test	Additional test single or double leaf doorset
B.2.3 Type of infill material	Change of supplier/ manufacturer of material with identical composition and properties	=	=	=	Possible	-
B.2.4 Type of infill material – see Table B.2.4	Alternative material	=	=	=	Possible providing the infill material is Euroclass A1 or A2-s1, d0 and is in accordance with the following table Otherwise not possible without an additional test	Additional test can be single or double leaf doorset

Construction Parameter	Variation	Influence of variation on performance characteristic			Possibility of extension	Additional Evidence Required
(1)	(2)	(3)			(4)	(5)
		E	I	W		

Table B.2.4 – Possible frame infill materials

Test with	Allows this material						
	No infill	Mineral wool	Gypsum board	Gypsum plaster	Mortar	Concrete	PU Foam
No infill	Yes	No for EI doors Yes for E and EW doors	No for EI doors Yes for E and EW doors	No for EI doors Yes for E and EW doors	No for EI doors Yes for E and EW doors	No for EI doors Yes for E and EW doors	No
Mineral wool	No	Yes *)	Yes	Yes	Yes	Yes	No
Gypsum board	No	No	Yes *)	Yes	Yes	Yes	No
Gypsum plaster	No	No	No	Yes *)	Yes	Yes	No
Mortar	No	No	No	Yes	Yes *)	Yes	No
Concrete	No	No	No	No	No	Yes *)	No
PU Foam	No	No	Yes	Yes	Yes	Yes	Yes

NOTE Mineral wool = glass, ceramic or stone wool of same or better reaction to fire classification
 *) Density can be increased but not decreased.

B.2.5 Thickness of metal - see Figure A.45 a)	Increase	≥	=	=	EI Possible in line with direct application or possible to a maximum of 50 % providing original test satisfied B overrun Above 50 % needs an additional test using a specimen with maximum required thickness	Additional test single or double leaf doorset
B.2.6 Thickness of metal - see Figure A.45 b)	Decrease	≤	=	=	Not possible without an additional test	Additional test single or double leaf doorset

Construction Parameter	Variation	Influence of variation on performance characteristic			Possibility of extension	Additional Evidence Required
(1)	(2)	(3)			(4)	(5)
		E	I	W		
B.2.7 Type of metal	Mild to stainless	=	=	=	Possible providing that the material thickness shall not be increased but may be decreased up to a maximum of 20 % Otherwise not possible without an additional test	Additional test single or double leaf doorset
B.2.8 Type of metal	Stainless to mild	=	=	=	Possible providing that the material thickness shall not be decreased but may be increased up to a maximum of 25 % Otherwise not possible without an additional test	Additional test single or double leaf doorset

C. Hardware

This document references EN 1634-2 where appropriate as the means to extend the parameters of building hardware. In general, this document provides additional guidance over and above that contained in EN 1634-2. It is a requirement of this document that all items of building hardware are in accordance with the relevant product standard including the requirements of the relevant supporting standards and that the door assembly onto which the building hardware will be fitted is appropriate to the intended durability of self-closing class (C Classification). Building hardware shall be suitable for use on fire doorsets and the suitability shall be demonstrated as specified in the component product standard.

For the purpose of this European Standard, when the suitability for use on fire doorsets is demonstrated by a successful full size fire test to EN 1634-1 or a small scale fire test to EN 1634-2, the test specimen shall be representative of the intended doorsets' construction and for the required classification period.

C.1. General

C.1.1 Latches/locks and strike plates	Alternative	>/=<	>/=<	=	Possible providing that the alternative lock is of the same type (internally mounted/morticed or surface mounted), complies with the relevant product standard, is suitable for use on the original doorset and has passed a full size fire test to EN 1634-1 or a small scale fire test to EN 1634-2. Each of the linear dimensions shall be no larger than tested successfully in the original doorset, and the latch bolt shall have a similar or greater engagement. Additionally, for internal locks, the amount of material removed from the door leaf shall be as tested in the original doorset or less. Any additional component should be metal and the distance between the intumescent protection, if fitted, and the lock forend or the strike plate shall remain as tested Otherwise not possible without an additional test	Equal or greater latch bolt engagement For single and double doors additional full scale test can be single leaf doorset (opening inwards) Smaller latch bolt engagement For single additional full scale test can be single leaf doorset (opening inwards) and for double doors double leaf doorset (opening inwards and outwards)
---------------------------------------	-------------	------	------	---	---	--

Construction Parameter	Variation	Influence of variation on performance characteristic			Possibility of extension	Additional Evidence Required
(1)	(2)	(3)			(4)	(5)
		E	I	W		
C.1.3 Number of latches/locks and strike plates - see Figure A.47	Decrease	≤	≤	=	Not possible without an additional full size test Unless originally tested with latch bolt (s) withdrawn Otherwise not possible without an additional test	For single doors additional full size test can be single or double leaf doorset For double doors additional full size test shall be double leaf doorset
C.1.4 Locking system	Exchange single latch/lock to multipoint locking system	≥	≤	=	EI Possible for surface mounted systems providing the full system has been successfully tested in a full scale test Otherwise not possible without an additional test Not possible for internal systems without an additional test	For single doors additional full size test can be single or double leaf doorset (opening inwards or outwards) For double doors additional full size test shall be double leaf doorset (opening outwards)
C.1.6 Position of single latch/lock/strike plate - see Figure A.48	Alternative	≤	≤	≤	Possible 300 mm variation for category B doors and possible 200 mm variation for category A Otherwise not possible without an additional test	For single doors additional full scale test can be single or double leaf doorset For double doors additional full scale test shall be double leaf doorset

Construction Parameter	Variation	Influence of variation on performance characteristic			Possibility of extension	Additional Evidence Required
(1)	(2)	(3)			(4)	(5)
		E	I	W		
C.1.7 Position of multiple latches/locks/strike plates (with or without connecting rods) - see Figure A.49	Alternative	=	=	=	<p>Possible providing the latches/locks have been tested in a full scale test with only the central latch in an engaged position and all others in disengaged condition</p> <p>Where the latches/locks have been tested in an engaged condition the distance from top of door leaf to top latch and bottom of door leaf to bottom latch cannot be changed. Possible variation of intermediate lock/latch only, plus or minus 200 mm</p> <p>Otherwise not possible without an additional test</p>	<p>For single doors additional full scale test can be single or double leaf doorset</p> <p>For double doors additional full scale test shall be double leaf doorset</p>
C.1.9 Latches/locks and strike plates of the same type	Alternative material	>/=/<	=	=	<p>Possible to interchange between mild steel and stainless steel or possible providing the component has been tested in a full scale or small scale test</p> <p>Otherwise not possible without an additional test</p>	Additional full scale test can be single or double leaf doorset
C.1.10 Latches/locks - see Figure A.50 a)	Exchange internal for external	>/=/<	≥	=	Not possible without an additional test	<p>For single doors additional full scale test can be single or double leaf doorset.</p> <p>For double doors additional full scale test shall be double leaf doorset</p>
C.1.11 Latches/locks - see Figure A.50 b)	Exchange external for internal	>/=/<	≤	=	Not possible without an additional test	<p>For single doors additional full scale test can be single or double leaf doorset</p> <p>For double doors additional full scale test shall be double leaf doorset</p>

Construction Parameter	Variation	Influence of variation on performance characteristic			Possibility of extension	Additional Evidence Required
(1)	(2)	(3)			(4)	(5)
		E	I	W		
C.1.13 Face mounted operating device (e.g. handles, knobs, panic bars, push or touch pads)	Remove				Possible to remove face mounted components providing the internal lock/latch assembly remains as tested and any remaining holes are adequately covered Otherwise not possible without an additional test	Additional full scale test can be single or double leaf doorset
C.1.14 Panic exit device or emergency exit device	Exchange internal for external	>/=<	≥	=	Not possible without an additional test	For single doors additional full scale test can be single or double leaf doorset For double doors additional full scale test shall be double leaf doorset
C.1.15 Panic exit device or emergency exit device	Exchange external for internal	>/=<	≤	=	Not possible without an additional test	For single doors additional full scale test can be single or double leaf doorset For double doors additional full scale test shall be double leaf doorset
C.1.16 Panic exit device or emergency exit device of the same type	Change of supplier/ manufacturer	>/=<	=	=	Possible providing the component has been tested in a full scale test Otherwise not possible without an additional test	Additional full scale test can be single or double leaf doorset (opening inwards or outwards)
C.1.17 Dimension of hinges	Increase	≥	=	=	Possible to increase any dimension up to a maximum of 50 % providing any inumescent seal and the position and type of fixing shall remain as tested Otherwise not possible without an additional test	Additional full scale test can be single or double leaf doorset. or small scale test according EN 1634-2
C.1.18 Dimension of hinges	Decrease	≤	=	=	Possible providing the component has been tested in an full scale or small scale test and all fixing details are replicated from the full scale test Otherwise not possible without an additional test	Additional full scale test can be single or double leaf doorset or small scale test according EN 1634-2

Construction Parameter	Variation	Influence of variation on performance characteristic			Possibility of extension	Additional Evidence Required
(1)	(2)	(3)			(4)	(5)
		E	I	W		
C.1.19 Dimension of dog bolts - see Figure A.51	Increase	≥	≥	≥	Possible to increase any dimension up to a maximum of 50 % providing any inumescent seal and the shape remains unchanged Otherwise not possible without an additional test	Additional full scale test can be single or double leaf doorset or small scale test according EN1634-2
C.1.20 Dimension of dog bolts - see Figure A.52	Decrease	≤	≤	≤	Not possible without an additional test	Additional full scale test can be single or double leaf doorset
C.1.21 Bolts (flush, internal and surface mounted) - see figure A.53	Add	>=/<	>=/<	=	Possible to add surface mounted bolts for single and double leaf doorsets EI Possible to add internal mounted bolts for secondary leaf on double leaf doorsets Otherwise not possible without an additional test	Additional full scale test can be single or double leaf doorset (opening inwards or outwards)
C.1.22 Bolts (flush, internal and surface mounted)	Remove	>=/<	>=/<	=	Possible if tested with the bolt withdrawn Otherwise not possible without an additional test	For single doors additional full scale test can be single or double leaf doorset For double doors additional full scale test shall be double leaf doorset
C.1.23 Bolts (flush, internal and surface mounted)	Alternative	>=/<	>=/<	=	Possible providing the component has been tested in a full scale or small scale test Otherwise not possible without an additional test	Additional full scale test can be single or double leaf doorset
C.1.24 Bolts (flush, internal and surface mounted)	Change of supplier/ manufacturer	>=/<	=	=	Possible	-
C.1.25 Number of hinges/dog bolts - see Figure A.54 a)	Increase	≥	≥	≥	Possible	-
C.1. 26 Number of hinges/dog bolts - see Figure A.54 b)	Decrease	≤	≤	≤	Not possible without an additional test	Additional full scale test can be single or double leaf doorset

Construction Parameter	Variation	Influence of variation on performance characteristic			Possibility of extension	Additional Evidence Required
(1)	(2)	(3)			(4)	(5)
		E	I	W		
C.1.27 Hinges/dog bolts of the same type	Change of supplier/ manufacturer	=	=	=	Possible	-
C.1.29 Type of dog bolts - see Figure A.56	Alternative material/type/ shape	>/=/<	>/=/<	>/=/<	Possible providing the component has been tested in a full scale or small scale test according EN1634-2 Otherwise not possible without an additional test	Additional full scale test can be single or double leaf doorset or small scale test according EN 1634-2
C.1.30 Distance from top of upper hinge to top of door - see Figure A.57 Based on all distortions	Increase	≤	=	=	Not possible without an additional test	Additional full scale test can be single or double leaf doorset
C.1.31 Distance from top of upper hinge to top of door - see Figure A.57	Decrease	≥	=	=	Possible	-
C.1.32 Distance from bottom of lower hinge to bottom of door - see Figure A.58	Increase	≤	=	=	Not possible without an additional test	Additional full scale test can be single or double leaf doorset
C.1.33 Distance from bottom of lower hinge to bottom of door - see Figure A.58	Decrease	≥	=	=	Possible	-
C.1.34 Distances between top and bottom hinges and intermediate movement restrictors (i.e. hinges or dog bolts) - see Figure A.59	Increase	≤	=	=	Possible in line with direct application only	-
C.1.35 Distances between top and bottom hinges and intermediate movement restrictors (i.e. hinges or dog bolts) - see Figure A.59	Decrease	≥	=	=	Possible	
C.1.36 Fixing technique for hinges (door leaf, frame)	Alternative (welding or riveting or screwing)	>/=/<	=	=	Possible providing the alternative fixing technique has been tested in a full scale test Otherwise not possible without an additional test	Additional full scale test can be single or double leaf doorset
C.1.37 Armature of an electrically powered separate hold open device	Add	=	=	=	Possible providing that the component is face mounted, made of metal or Euroclass A1 material and that any break through is limited to screw fixings and their covering Otherwise not possible without an additional test	Additional full scale test can be single or double leaf doorset

Construction Parameter	Variation	Influence of variation on performance characteristic			Possibility of extension	Additional Evidence Required
(1)	(2)	(3)			(4)	(5)
		E	I	W		
C.1.38 Electrically powered hold open device	Exchange original concealed for alternative face mounted	>/=/<	≥	=	<p>Possible providing that the alternative unit complies with the EN 1155, is suitable for use on the original doorset and no voids remain in the doorset</p> <p>The cable shall be external or, if it is internal, it shall require the same preparation in the door leaf and in the frame as tested in the original doorset</p> <p>The intumescent protection, if fitted, shall remain the same as tested</p> <p>Otherwise not possible without an additional test</p>	Further test is to include the required item tested in accordance with EN 1634-1 or EN 1634-2 on a representative doorset construction
C.1.39 Electrically powered hold open device	Exchange original face mounted for alternative concealed	>/=/<	≤	=	Not possible without an additional test	Further test is to include the required item tested in accordance with EN 1634-1 or EN 1634-2 on a representative doorset construction
C.1.40 Electrically powered hold open device	Change of manufacturer/ alternative	>/=/<	>/=/<	=	<p>Possible providing that the alternative and the original door devices are of the same type, internal or surface mounted, the alternative device complies with the EN 1155 and is suitable for use on the original doorset. For concealed items, the size of the alternative item cannot be greater than tested in the original doorset and the material removed from the door shall be as tested or less</p> <p>The cable shall be external or, if it is internal, it shall require the same preparation in the door leaf and in the frame as tested in the original doorset. The intumescent protection, if fitted, shall remain the same as tested</p> <p>Otherwise not possible without an additional test</p>	Further test is to include the required item tested in accordance with EN 1634-1 or EN 1634-2 on a representative doorset construction

Construction Parameter		Variation	Influence of variation on performance characteristic			Possibility of extension	Additional Evidence Required
(1)		(2)	(3)			(4)	(5)
			E	I	W		
C.1.41 Face fixed door closer (face fixed to face fixed, mounted on the closing or opening side of the doorset) – see Figure A.60		Alternative fitting positions in accordance with table below	–	–	–	Possible providing the closer has been tested in a full scale test in disengaged condition, with the door leaf opening outwards and is in accordance with the table below Otherwise not possible without an additional test	Additional full scale test can be single or double leaf doorset
	Tested	Allows					
	A	A	-	C	-		
	B	-	B	C	D		
	C	-	-	C	-		
	D	-	-	C	D		
C.1.42 Face fixed door closer		Alternative	=	=	=	Possible providing the alternative closer has been tested in a full scale or small scale test according EN1634-2 Otherwise not possible without an additional test	Additional full scale test can be single or double leaf doorset or small scale test according EN 1634-2
C.1.43 Concealed door closer (mounted in the door leaf or the frame)		Alternative	=	=	=	Possible providing the closer has been tested in a full scale test with the door leaf opening outwards, and that the size of the cut-out is not increased from that tested. If tested with EI doors only, the result is only applicable to EI doors but if tested on uninsulated E doors the result is applicable to EI, EW and E doors Otherwise not possible without an additional test	Additional full scale test can be single or double leaf doorset
C.1.44 Concealed door closer		Change of location (door leaf to frame or <i>vice versa</i>)	>/=<	>/=<	>/=<	Not possible without an additional test	Additional full scale test can be single or double leaf doorset
C.1.45 Door closer - see Figure A.61 and A.62		Change of location (concealed for face mounted or <i>vice versa</i>)	>/=<	>/=<	>/=<	Not possible without an additional test	Additional full scale test can be single or double leaf doorset

Construction Parameter	Variation	Influence of variation on performance characteristic			Possibility of extension	Additional Evidence Required
(1)	(2)	(3)			(4)	(5)
		E	I	W		
C.1.46 Power cable and protective conduits for electric locks (fitted in the door leaf or frame) - see Figure A.63	Add	=	=	=	<p>Possible to add power cable and conduit providing the positioning of such cable or conduit shall not detract from the rigidity of any stiffening element and the conduit inside the door leaf and frame is made of metal. Where the door leaf and the frame are connected via a cable transfer device it also has to be metal and any cut out in the door leaf and frame should not reduce the intumescent seal, if any</p> <p>Where the cable is outside the leaf and frame the conduit has to be of metal and have a diameter not greater than 16 mm</p> <p>Otherwise not possible without an additional test</p>	Additional full scale test can be single or double leaf doorset
C.1.47 Spy holes/key tubes - see Figure A.64	Add	=	=	=	<p>Possible providing that the component has been tested in either a full scale or small scale test according EN 1634-2 in a similar leaf construction</p> <p>Otherwise not possible without an additional test</p>	Additional full scale test can be single or double leaf doorset or small scale test according EN 1634-2
C.1.48 Alarm contacts and proximity switches	Add	=	=	=	Possible	-
C.1.49 Alarm contacts and proximity switches	Alternative	=	=	=	Possible	-
C.1.50 Door signs (Euroclass A1)	Add	=	=	=	<p>Possible providing that any break through is limited to screw fixings and their covering and that the fixings do not break both sides</p> <p>Otherwise not possible without an additional test</p>	Additional full scale test can be single or double leaf doorset or small scale test according EN 1634-2
C.1.51 Door signs (< Euroclass A1)	Add	=	=	=	<p>Possible for EI doorsets only providing that the fixing do not break both sides and the location is at least 100 mm from the edge of the door leaf</p> <p>Otherwise not possible without additional test</p>	Additional full scale test can be single or double leaf doorset or small scale test according EN 1634-2

Construction Parameter	Variation	Influence of variation on performance characteristic			Possibility of extension	Additional Evidence Required
(1)	(2)	(3)			(4)	(5)
		E	I	W		
C.1.52 Pivots with single action accessories (shoe & top centre) with or without floor/transom mounted closing devices	Exchange from hinges	≤	≤	≤	Not possible without an additional test	Additional test to include the specific closer and accessories For single leaf doorsets additional full scale test single leaf or double leaf doorset , for double leaf doorsets additional full scale test double leaf doorset
C.1.53 Pivots with single action accessories (shoe & top centre) with or without floor/transom mounted closing devices	Exchange to hinges				Possible providing the hinges, including fixing technique and hinge positions, have been successfully tested on a similar doorset and providing a previously proven closing device is added Otherwise not possible without additional test	Additional full scale test can be single or double leaf doorset
D. Support/attachment - door leaf to framing						
D.1. General						
D1.1. Gap dimensions (door leaf to frame)	Increase/decrease	≤	≤	≤	Possible in line with direct application beyond the field of direct application rules Not possible without an additional test	Additional test can be single or double leaf doorset (worst case direction)

Construction Parameter	Variation	Influence of variation on performance characteristic			Possibility of extension	Additional Evidence Required
(1)	(2)	(3)			(4)	(5)
		E	I	W		
E. Side/transom panels and flush over panels						
Existing direct application rules for size variations, side and over panels, door leaves and frames are also applicable for variations in side, transom panels and flush over panels.						
E.1. Side, over and transom panel arrangements						
Before there can be any consideration for the variation in side and over panel arrangements, the doorset shall have been tested in accordance with EN 1634-1 to achieve a test result which could generate a classification in accordance with EN 13501-2 at least equal to the classification subsequently required from extended application considerations.						
If the original doorset test was conducted only on a single doorset without side/over panels then only the single door arrangements from the following variations will be permissible. If the original doorset test was conducted only on a double doorset without side/over panels then only the double door arrangements from the following variations will be permissible.						
Variations outside the arrangements in Figures B.1 and B.2 together with Tables B.1 and B.2 are possible if the proposed alternative arrangement is covered by variations permitted in other parts of this European Standard. If a variation is not covered, an additional test will be necessary.						
E.1.1 Side/transom panel arrangement - see Annex B – Figure B.1	Additional or variations of alternative arrangements in accordance with Table B.1 in Annex B	≤	≤	≤	A successful test on an arrangement indicated in the left hand column of Table B.1 would allow the variations in arrangement indicated by an 'X' in the same row assuming the fixing/retention method of the panelling system is retained Otherwise not possible without additional, specific test	Test using test specimens according Annex B – Figure B.1 (opening outwards from the furnace)
E.1.2 Side/flush over panel arrangement - see Annex B – Figure B.2	Additional or variations of alternative arrangements in accordance with Table B.2 in Annex B	≤	≤	≤	A successful test on an arrangement indicated in the left hand column of Table B.2 would allow the variations in arrangement indicated by an 'X' in the same row assuming the fixing/retention method of the panelling system is retained Otherwise not possible without additional, specific test	Test using test specimen according Annex B – Figure B.2 (open outwards from the furnace)
E.1.3 Hinged flush over panel arrangement instead of fixed panel	Alternative	≤	≤	≤	Not possible without an additional test	Test using test specimen according Annex B – Figure B.2 incorporating hinged over panel (open outwards from the furnace)
E.1.4 Fixed flush over panel arrangement instead of hinged panel	Alternative	≥	≥	≥	Possible	-
E.1.5 Cut outs in panels (penetration)	Add	>=/<	>=/<	>=/<	Possible within the size limits of the intended penetration system	-

Construction Parameter	Variation	Influence of variation on performance characteristic			Possibility of extension	Additional Evidence Required
(1)	(2)	(3)			(4)	(5)
		E	I	W		
E.2. General						
For variations of intumescent/draught/smoke seals, the rules defined in section A.1 are applicable for side/transom panels and flush over panels.						
For variations of rebates to panel edges, the rules defined in A.1. are applicable for side/transom panels and flush over panels.						
E.3. Size variations						
E.3.1 Size (area, width, height) – all distortions	Decrease	≥	≥	≥	EI Possible in line with direct application or possible providing the distance between the fixing points is reduced by at least 25 % or from the size tested down to size of a second test specimen in the same design Otherwise not possible without an additional test	Additional test smaller leaf/panel arrangement incorporating single or double leaf doorset
E.3.3 Thickness of the panel (excluding glazing covered in Section F) Based on high distortion	Increase	≥	≥	≥	Not possible without an additional test	Additional test single or double leaf doorset with a panel
Based on medium distortion		>=/<	≥	≥	Possible providing the same increase of thickness of core material by a maximum of 10 % Otherwise not possible without an additional test	Additional test single or double leaf doorset with a side, over and transom panel arrangement
Based on low distortion		>=/<	≥	≥	Possible providing the same increase of thickness of core material by a maximum of 25 % Otherwise not possible without an additional test	Additional test single or double leaf doorset with side, over and transom panel arrangement
E.3.4 Thickness of the panel (excluding glazing covered in Section F)	Decrease	>=<	≤	≤	EI Not possible without an additional test	Additional test single or double leaf doorset with a side, over and transom panel arrangement
E.4. Materials and construction						
For further "Materials and Construction" parameters, refer to section A.3 If additional tests need to be conducted, the specimen shall incorporate appropriate side/transom and flush over panel arrangements.						
For variations of intumescent/draught/smoke seals, the rules defined in section A.3 are applicable for side/transom and flush over panel arrangements.						
E.4.1 Material of panel	Alternative	=	=	=	Not possible without an additional test	Additional test single or double leaf doorset with a panel

Construction Parameter	Variation	Influence of variation on performance characteristic			Possibility of extension	Additional Evidence Required
(1)	(2)	(3)			(4)	(5)
		E	I	W		
E.4.2 Type of steel sheet	Mild to stainless	=	=	=	Possible providing that the material thickness shall not be increased but may be decreased up to a maximum of 20 % Otherwise not possible without an additional test	Additional test single or double leaf doorset with a panel
E.4.3 Type of steel sheet	Stainless to mild	=	=	=	Possible providing that the material thickness shall not be decreased but may be increased up to a maximum of 25 % Otherwise not possible without an additional test	Additional test single or double leaf doorset with a panel
E.5 Decorative and/or protective finishes						
For further "Decorative and/or protective finishes" parameters, refer to section A.4.						
F. Glazing for door leaf/leaves or side/transom and flush over panels						
F. 1 General						
Glass panels on their own do not have a classification. The fire resistance classification is derived from testing in specific edge framing techniques. Where fire performance classifications are referred to in this section, they may be determined by alternative testing of glass panels of the same or larger height and/or width to those tested by the particular door test(s). Where "similar edge fixing technique" is referred to, this means that the technique used in the original door test should be replicated exactly in terms of the retention detail or that the technique may be modified to accommodate a technique proven in an alternative test to determine fire performance characteristics. For double leaf doorsets, both leaves shall be similarly glazed unless tested to show maximum and minimum amounts of leaf cut out in opposing leaves of the same double leaf doorset after which time any sizes of leaf cut out in between those tested are acceptable.						
F.1.1 Glazed aperture	Add	>=<	>=<	>=<	Not possible without an additional test	Additional full scale test can be single or double leaf doorset
F.1.4 Glazed aperture	Size variation between smallest and largest tested glazed aperture	-	-	-	Possible in accordance with the table below Otherwise not possible without an additional test	Additional full scale test can be single or double leaf doorset in accordance with the table below

Construction Parameter	Variation	Influence of variation on performance characteristic			Possibility of extension	Additional Evidence Required
(1)	(2)	(3)			(4)	(5)
		E	I	W		

Tested		Allows		
no. of leaves	dimension of glazed aperture	single leaf doorset (range of dimension)	double leaf doorset (range of dimension)	
			primary leaf	secondary leaf
single	largest	largest minus 25 % up to largest	largest minus 25 % up to largest	largest minus 25 % up to largest
single (two tests)	smallest + largest	smallest up to largest	smallest up to largest	smallest up to largest
double	primary	largest	smallest up to largest	smallest up to largest
	secondary	smallest		
double	primary	smallest	smallest	smallest up to largest
	secondary	largest		
double	primary	largest	largest minus 25 % up to largest	largest minus 25 % up to largest
	secondary	none		
double	primary	none	none	largest minus 25 % up to largest
	secondary	largest		

Rules in D.A. relating to distance between the edge of glazing and the perimeter of each leaf are applicable.

Construction Parameter	Variation	Influence of variation on performance characteristic			Possibility of extension	Additional Evidence Required
(1)	(2)	(3)			(4)	(5)
		E	I	W		
F.1.5 Thickness of glass - see Figure A.66 a)	Increase	≥	≥	≥	<p>Possible to exchange one thickness of fire-resistant glass for another with the same (or better) fire resistance performance provided that it can be demonstrated that the new glass of the thickness required is within the same glass product family (same manufacturer) and has a similar edge fixing technique only modified to accommodate the alternative thickness and that the alternative thickness does not add more than 25 % to the weight of the door leaf</p> <p>Otherwise not possible without an additional test</p> <p>Glass Product Family is defined in EN 15254-4:2008+A1:2011, 3.7.</p>	Additional full scale test can be single or double leaf doorset
F.1.6 Thickness of glass - see Figure A.66 b)	Decrease	>=/<	>=/<	>=/<	<p>Possible to exchange one thickness of fire-resistant glass for another with the same (or better) fire resistance performance provided that it can be demonstrated that the new glass of the thickness required is within the same glass product family (same manufacturer) and has a similar edge fixing technique only modified to accommodate the alternative thickness</p> <p>Otherwise not possible without an additional test</p> <p>Glass Product Family is defined in EN 15254-4:2008+A1:2011, 3.7.</p>	Additional full scale test can be single or double leaf doorset
F.1.7 Dimensions of each glazed aperture - see Figure A.67	Increase	≤	≤	>=/<	<p>Possible to increase the size and change the aspect ratio in line with EN 15254-4 providing the distance between the edge of glazing and the perimeter of the door leaf/panel is not decreased</p> <p>Otherwise not possible without an additional test</p>	Additional full scale test can be single or double leaf doorset in accordance with F.1.4
F.1.8 Dimensions of each glazed aperture - see Figure A.68	Decrease	≥	≥	>=/<	<p>Possible in line with direct application</p> <p>Otherwise not possible without an additional test</p>	Additional full scale test can be single or double leaf doorset in accordance with F.1.4

Construction Parameter	Variation	Influence of variation on performance characteristic			Possibility of extension	Additional Evidence Required
(1)	(2)	(3)			(4)	(5)
		E	I	W		
F.1.9 Type of glass	Change of glass type	=	=	=	<p>Possible to exchange one type of fire-resistant glass for another with the same (or better) fire resistance classification provided that it can be demonstrated that both glasses are within the same glass product family (same manufacturer) and have at least the same or increased nominal thickness</p> <p>For glass covered by the product standards EN 572-9, EN 1748-2 and EN 13024-2, it is possible to exchange one type of fire-resistant glass for another with the same (or better) fire resistance classification provided that it can be demonstrated that the new glass is within the same glass Product Standard and has a similar edge fixing technique</p> <p>Otherwise not possible without an additional test</p>	Additional full scale test can be single or double leaf doorset
F.1.10 Materials and geometry of edge fixing technique (with the same glass type)	Alternative	>/=<	>/=<	>/=<	Not possible without an additional test	Additional full scale test to EN 1634-1 can be single or double leaf doorset or for low distortion doors only to EN 1364-1
F.1.11 Decorative capping - see Figure A.69	Add or exchange	>/=<	=	=	<p>Possible providing the edge fixing technique is not affected and the capping is Euroclass A1</p> <p>Otherwise not possible without an additional test</p>	Additional full scale test can be single or double leaf doorset
F.1.12 Type and number of edge fixings (e.g. clips, screws, rivets)	Alternative	=	=	=	<p>Possible to interchange between fixings providing centre distances are not exceeded and providing the critical components have a melting point higher than 850 °C but where it is proven that the critical components have been successfully tested with a melting point lower than 850 °C, these may be interchanged with similar components</p> <p>Otherwise not possible without an additional test</p>	Additional full scale test can be single or double leaf doorset

Construction Parameter	Variation	Influence of variation on performance characteristic			Possibility of extension	Additional Evidence Required
(1)	(2)	(3)			(4)	(5)
		E	I	W		
F.1.13 Shape of glazing	Interchange between rectangular and round	=	=	=	Possible to change the shape of the tested glass in line with EN 15254-4 providing the distance between the edge of glazing and the perimeter of the door leaf/panel is not decreased Otherwise not possible without an additional test	Additional full scale test can be single or double leaf doorset
F.1.14 Number of glazed apertures - see Figure A.70	Increase	=	≤	≥	Possible providing the distance between glazed apertures has been tested, providing this distance is not reduced and providing the tested glazed area is not to be exceeded (smallest tested distance between edge of panes and perimeter of door leaf/panel is not decreased) Otherwise not possible without an additional test	Additional full scale test can be single or double leaf doorset
F.1.15 Number of glazed apertures - see Figure A.71	Decrease	=	≥	≤	Possible to reduce to a minimum of one (in line with F.1.2) providing this distance between the apertures is not reduced Otherwise not possible without an additional test	Additional full scale test can be single or double leaf doorset
F.1.16 Smallest tested distance between the edge of glazing and the perimeter of the door leaf/panel - see Figure A.72	Increase	≥	≥	=	Possible	-
F.1.17 Smallest tested distance between the edge of glazing and the perimeter of the door leaf/panel - see Figure A.73	Decrease	≤	≤	=	Not possible without an additional test	Additional full scale test can be single or double leaf doorset
F.1.18 Distance between glazed apertures	Increase	≥	≥	=	Possible	-
F.1.19 Distance between glazed apertures - see Figure A.74	Decrease	≤	≤	=	Not possible without an additional test	Additional full scale test can be single or double leaf doorset
G Supporting construction and attachment (technique) of door frame or side/transom panels/flush over panels						
G.1 General						
G.1.1 Supporting construction	Flexible to rigid	>=/<	>=/<	>=/<	Not possible without an additional test	Additional full scale test can be single or double leaf doorset
G.1.2 Supporting construction	Rigid to flexible	>=/<	>=/<	>=/<	EI Not possible without an additional test	Additional full scale test can be single or double leaf doorset

Construction Parameter	Variation	Influence of variation on performance characteristic			Possibility of extension	Additional Evidence Required
(1)	(2)	(3)			(4)	(5)
		E	I	W		
G.1.3 Supporting construction	Standard to associated and <i>vice versa</i>	>=/ <	>=/ <	>=/ <	Not possible without an additional test	Additional full scale test can be single or double leaf doorset
G.1.4 Attachment technique	Alternative built-in frame anchor to plug & screw and <i>vice versa</i>	>=/ <	>=/ <	>=/ <	Possible providing the fixings are appropriate to the construction and have been successfully tested in similar supporting construction and the distance between the fixings is not increased Otherwise not possible without an additional test	Additional full scale test can be single or double leaf doorset
G.1.5 Type of fixings	Alternative manufacturer/supplier	=	=	=	Possible	-
G.1.6 Type of fixings	Alternative material	≤	≤	≤	Possible to interchange between alternative fixing material providing centre distances are not increased and providing the critical components have a melting point higher than 850 °C. Where it is proven that the critical components have been successfully tested with a melting point lower than 850 °C, these may be interchanged with similar components Otherwise not possible without an additional test	Additional full scale test can be single or double leaf doorset
G.1.7 Number and size of fixings	Increase	≥	≥	≥	Possible	-
G.1.8 Number and size of fixings	Decrease	≤	≤	≤	Not possible without an additional test	Additional full scale test can be single or double leaf doorset with or without a panel in the same type of supporting construction
G.1.10 Distance between fixings	Decrease	≥	≥	≥	Possible	-
G.1.11 Fixing to floor - see Figure A.75 a)	Cleated to sunk	≥	≥	≥	Possible	-
G.1.12 Fixing to floor - see Figure A.75 b)	Sunk to cleated	≤	≤	≤	Not possible without an additional test	Additional full scale test can be single or double leaf doorset with or without a panel

Construction Parameter	Variation	Influence of variation on performance characteristic			Possibility of extension	Additional Evidence Required
(1)	(2)	(3)			(4)	(5)
		E	I	W		
G.1.13 Gap between door leaf and floor - see Figure A.76	Increase	≤	≥	≥	Possible up to a 50 % increase in the tested gap size but limited to a maximum of 25 mm total gap size Otherwise not possible without an additional test	Additional full scale test can be single or double leaf doorset
G.1.14 Gap between door leaf and floor - see Figure A.77	Decrease	≥	≥	≥	Possible	-
G.2 Modified supporting construction						
G.2.1 Standard flexible supporting construction - see Figure A.78	Strengthened to accommodate fixing requirements	>=/<	>=/<	>=/<	Not possible without an additional test	Additional full scale test can be single or double leaf doorset
G.3 Associated supporting construction						
G.3.1 Material and assembly technique	Change	>=/<	>=/<	>=/<	Not possible without an additional test	Largest size arrangement to be tested in each different associated construction

Figures referred to in table A

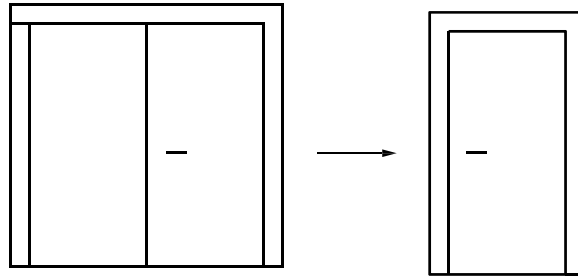

Figure A.1 - Number of leaves

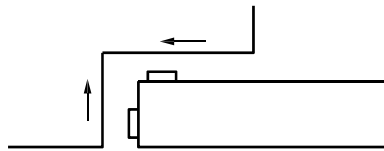

Figure A.3 - Intumescent seals between frame and door leaf/leaves

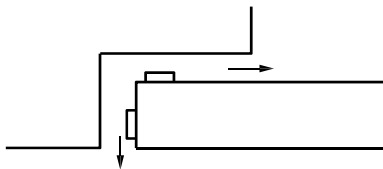

Figure A.4 - Intumescent seals between frame and door leaf/leaves

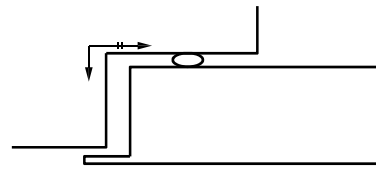

Figure A.5 - Non-intumescent seals between frame and door leaf/leaves - Euroclass A1, (fitted in leaf or frame) - Location

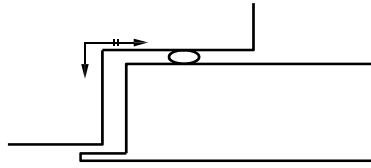

Figure A.6 - Non-intumescent seals between frame and door leaf/leaves - Euroclass A1, (fitted in leaf or frame)
 - Location

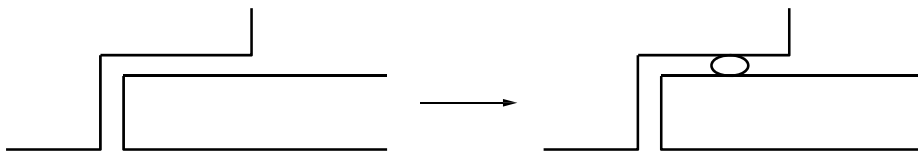

Figure A.7 - Non-intumescent seals between frame and door leaf/leaves - Euroclass A1, (fitted in leaf or frame)
 - Add

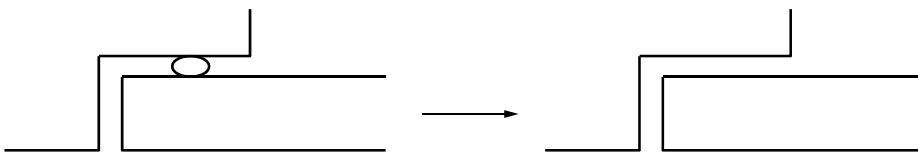

Figure A.8 - Non-intumescent seals between frame and door leaf/leaves - Euroclass A1, (fitted in leaf or frame)
 - Remove

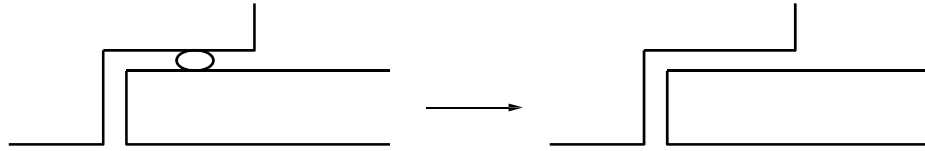
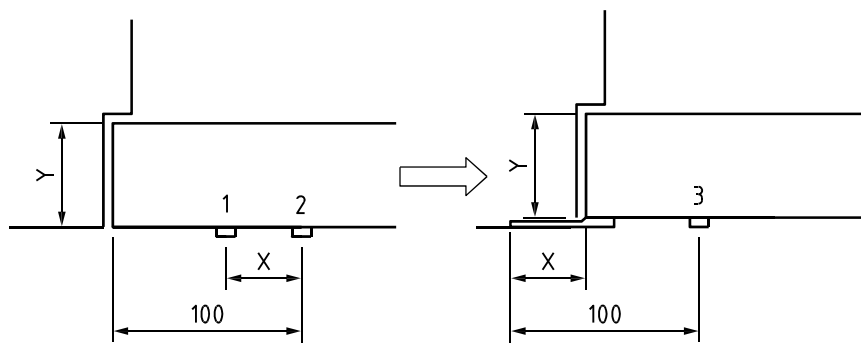

Figure A.10 - Non intumescent seals between frame and door leaf / leaves - < Euroclass A1, (fitted in leaf or frame) - Remove

Dimensions in millimetres



- 1 additional thermocouple
- 2 essential thermocouple
- 3 notional thermocouple position
- X rebate width, Y overlap dimension

Figure A.14 a) - Rebate (door leaves to frames) - Add

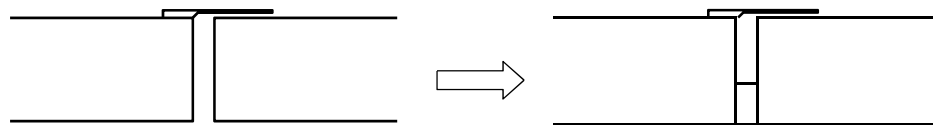

Figure A14 b) - Rebate (meeting edges) - Add (one rebate)

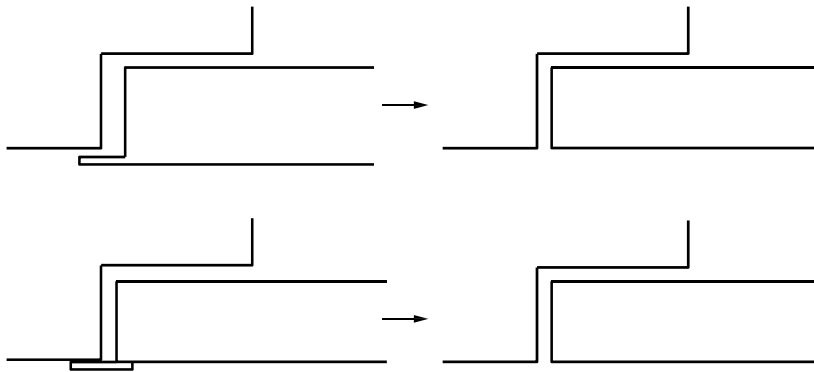

Figure A.15 - Rebate (door leaves to frames) - Remove

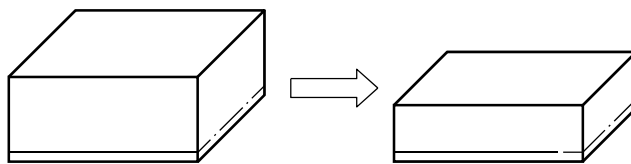

Figure A.17 - Thickness of core material - Decrease

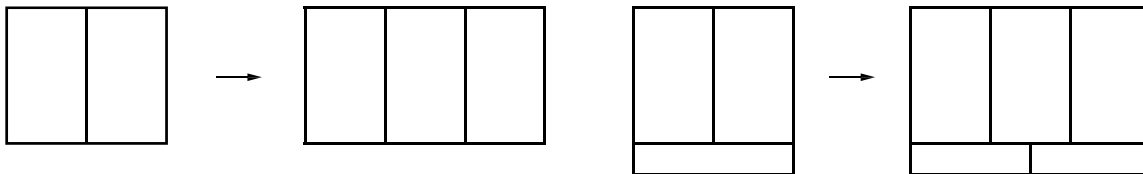
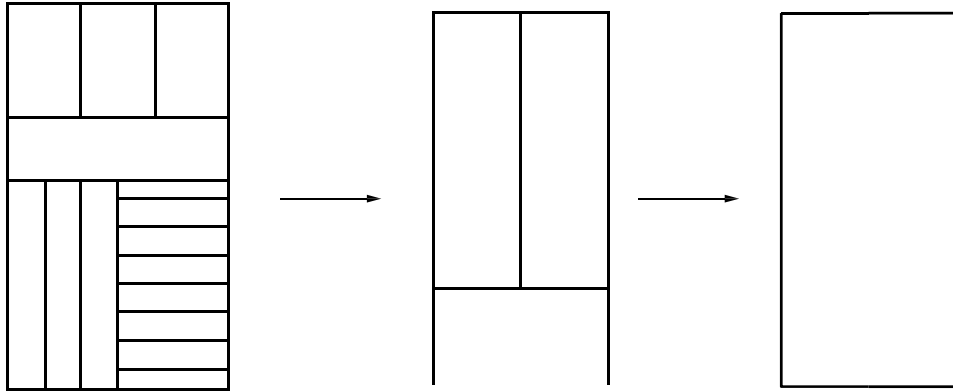

Figure A.18 - Pattern of core material (Increase number of pieces) - two examples shown



FigureA.19 - Pattern of core material - Decrease number of pieces

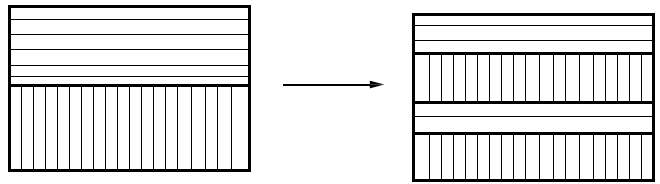

Figure A.20- Number of layers of identical and/or different materials - Increase

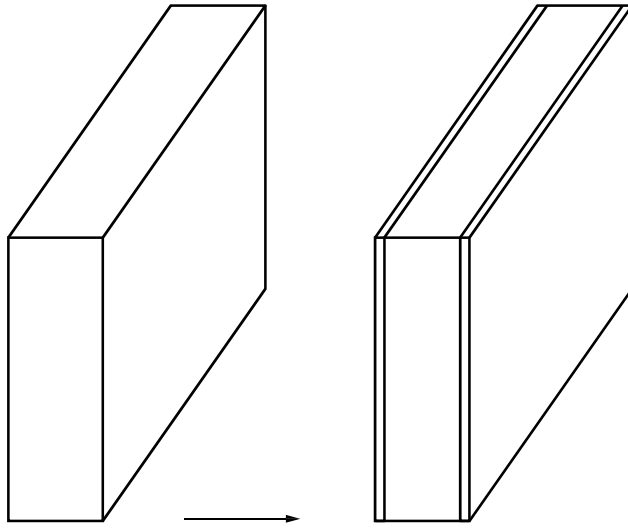

Figure A.22 a) - Metal armour sheet (internally mounted) - Add

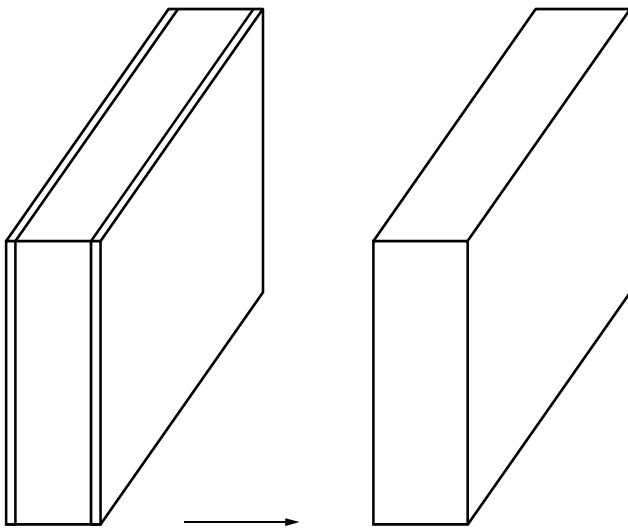
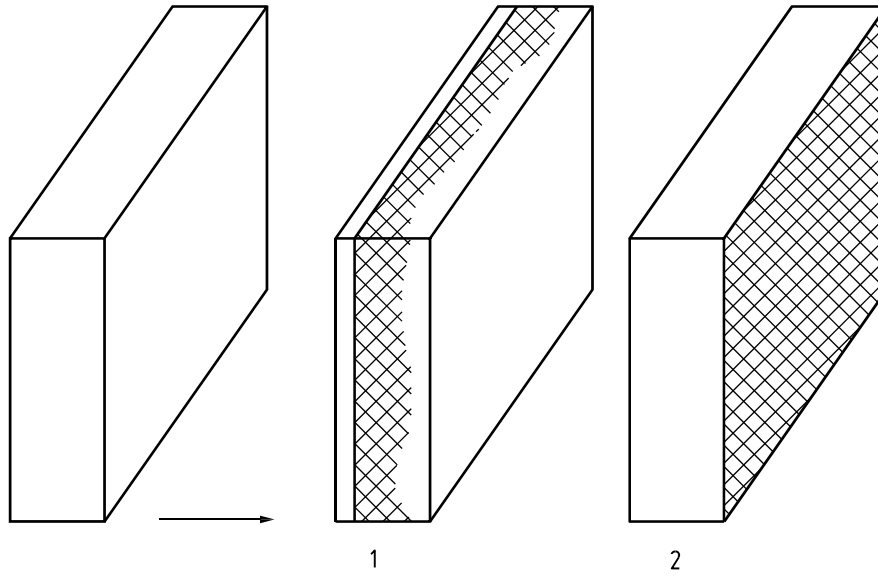

Figure A.22 b) - Metal armour sheet (internally mounted) - Remove



Key

- 1 internal
- 2 face fixed

Figure A.23 a) - Electronic security mesh - Add

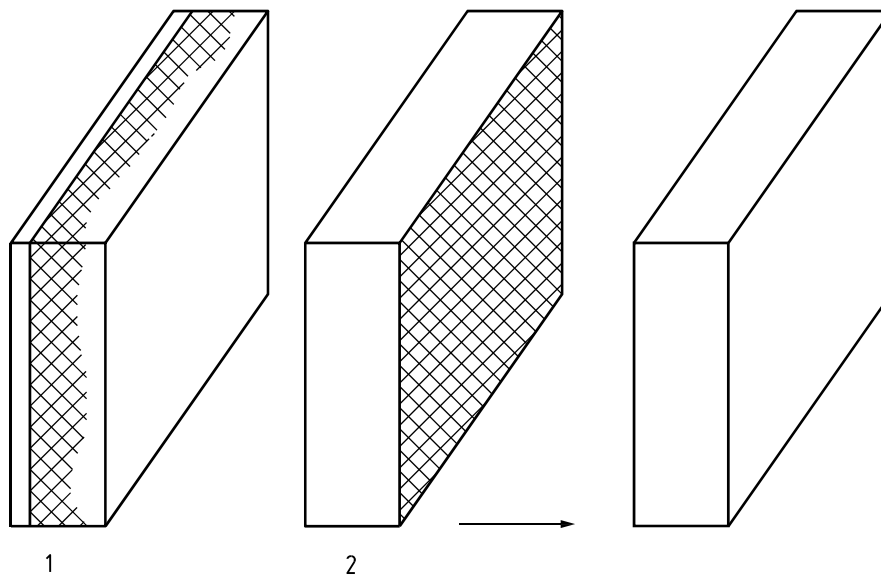

Key

- 1 internal
- 2 face fixed

Figure A.23 b) - Electronic security mesh - Remove

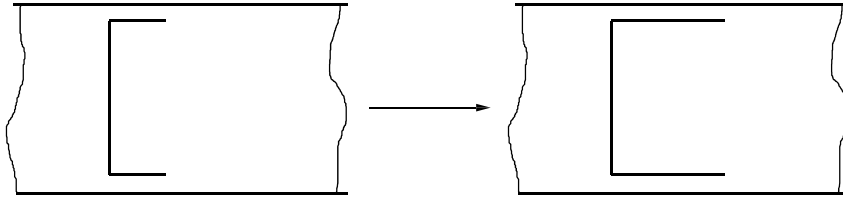

Figure A.24 a) - Cross-section dimension of stiffening elements - Increase

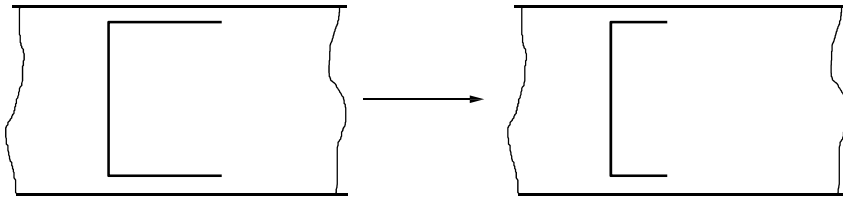

Figure A.24 b) - Cross-section dimension of stiffening elements - Decrease

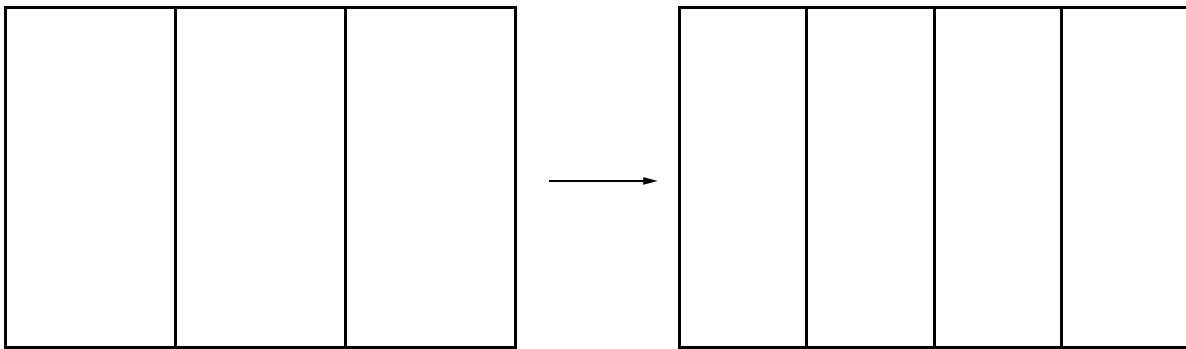

Figure A.25 a) - Number of intermediate stiffening elements - Increase

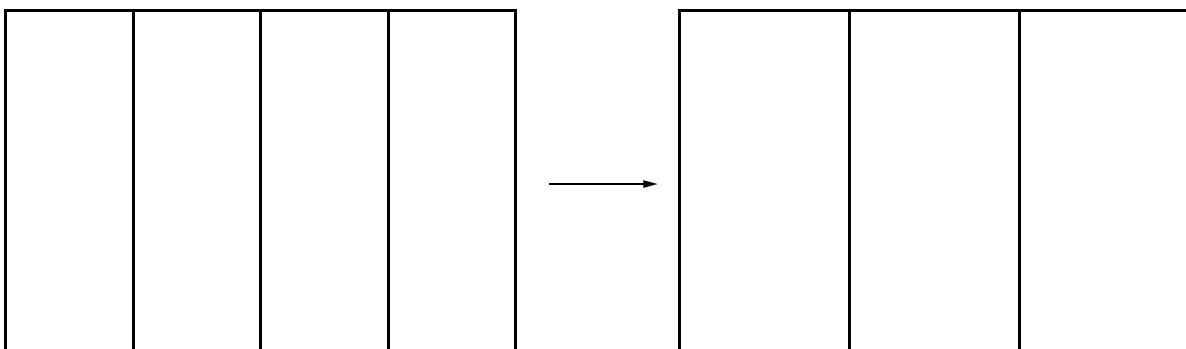

Figure A.25 b) - Number of intermediate stiffening elements - Decrease

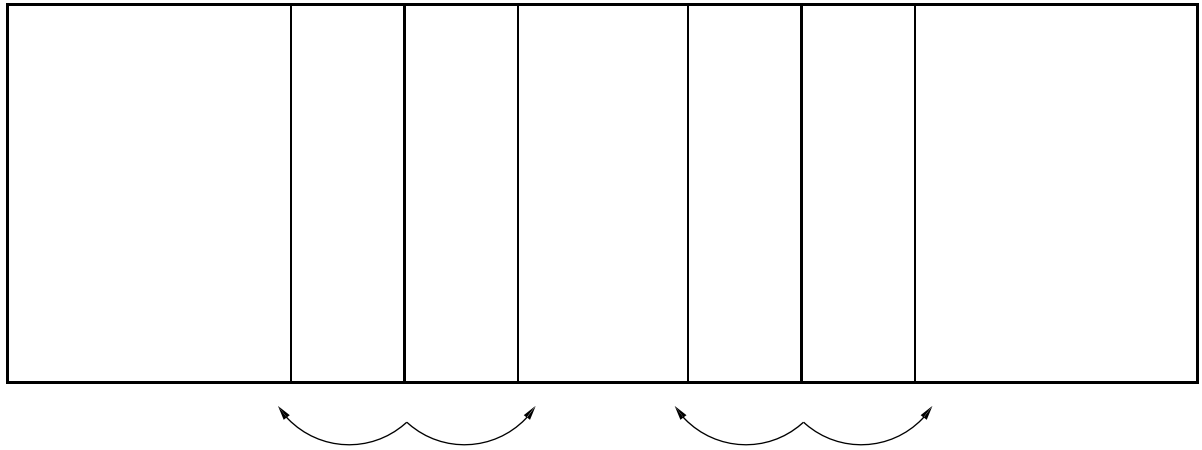

Figure A.26 - Stiffening elements - Location

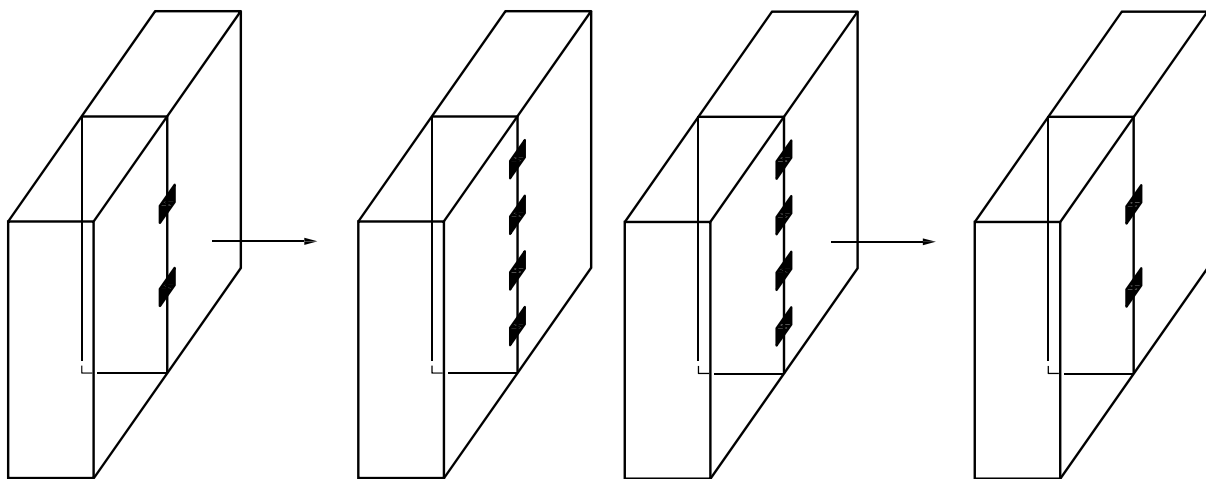
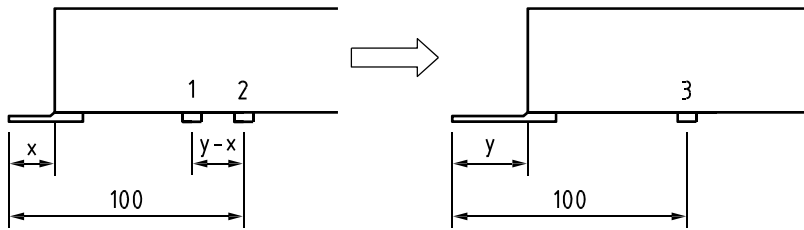

Figure A.27 a) - Number of stiffening element fixing points - Increase

Figure A.27 b) - Number of stiffening element fixing points - Decrease

Dimensions in millimetres



- 1 additional thermocouple
- 2 essential thermocouple
- 3 notional thermocouple position
- 4 $Y > X$ overlap dimensions

Figure A.28 a) - Overlap dimension of leaf edge rebate (between leaf and frame) - Increase

Dimensions in millimetres

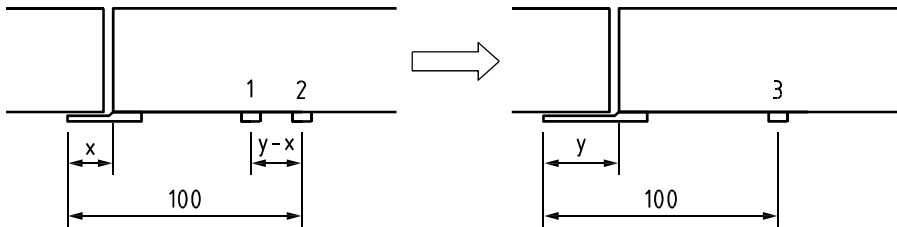

- 1 additional thermocouple
- 2 essential thermocouple
- 3 notional thermocouple position
- 4 $Y > X$ overlap dimensions

Figure A.28 b) - Overlap dimension of panel edge rebate (meeting edges) - Increase

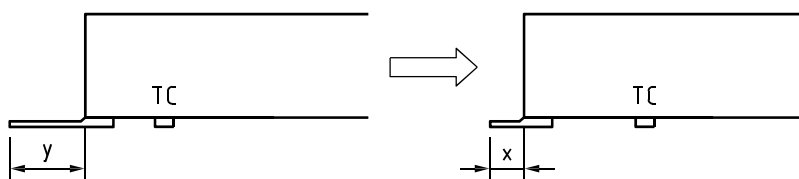

- TC thermocouple
- $Y > X$ overlap dimensions

Figure A.29 a) - Overlap dimension of leaf edge rebate (between leaf and frame) - Decrease

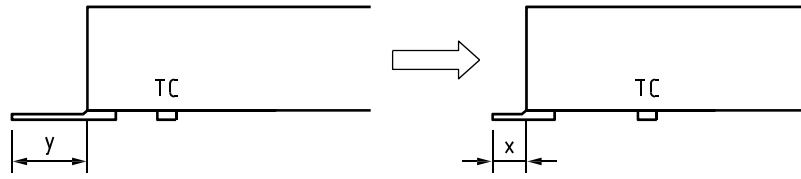

TC thermocouple
 $Y > X$ overlap dimensions

Figure A.29 b) - Overlap dimension of panel edge rebate (meeting edges) - Decrease

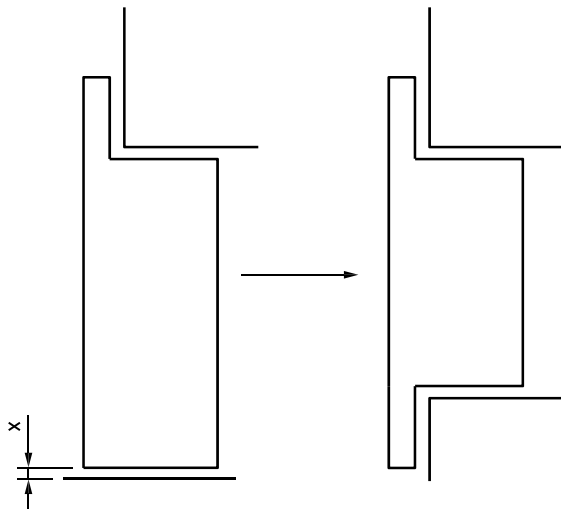
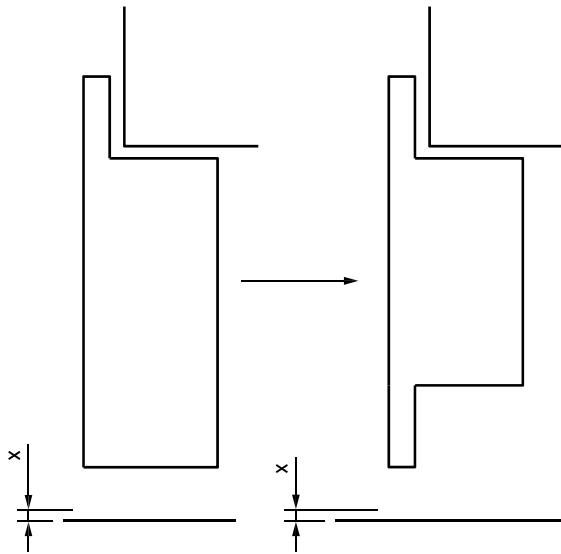

X gap

Figure A.30 a) - Additional overlapping edge at the bottom of the door leaf - Add

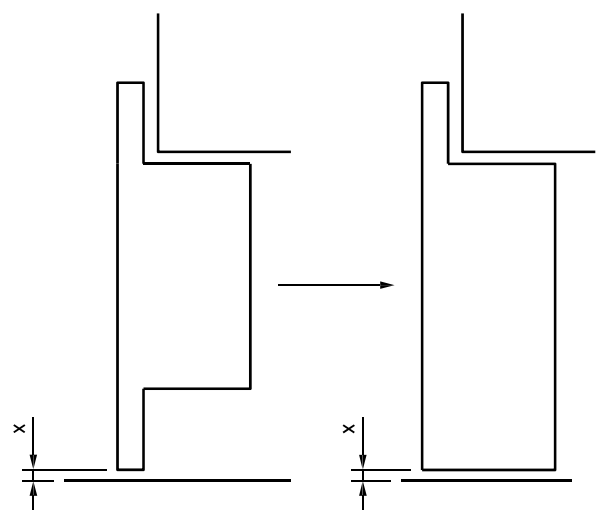

X gap

Figure A.30 b) - Additional overlapping edge at the bottom of the door leaf - Remove

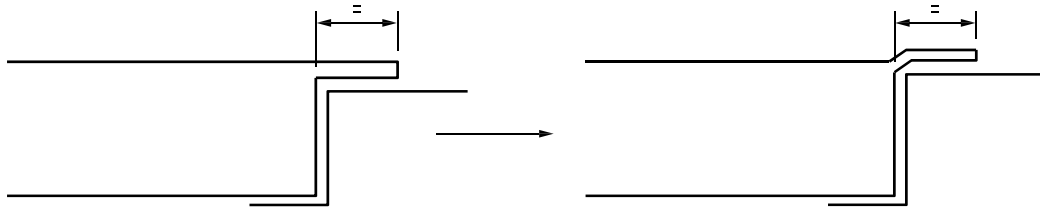
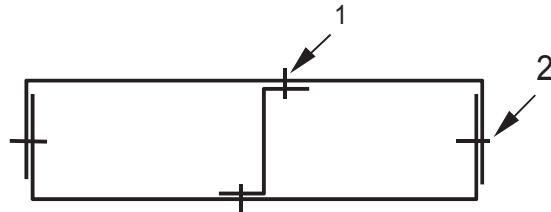

Figure A.31 - Leaf edge detail - Shape



- 1 stiffening elements
- 2 leaf edges

Figure A.32 - Jointing/assembly technique (Alternative - welding/riveting/screwing)

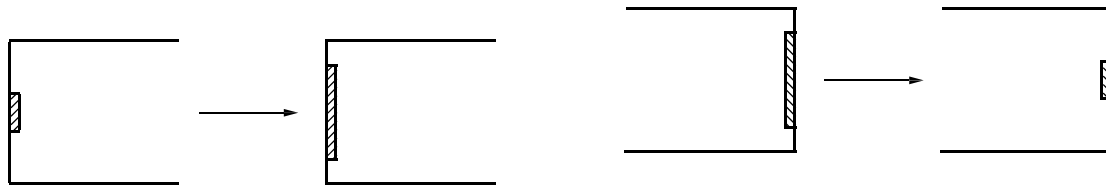

Figure A.33 a) - Dimension of intumescent seals (leaf or frame fitted) - Increase

Figure A.33 b) - Dimension of intumescent seals (leaf or frame fitted) - Decrease



Figure A.34 a) - Dimension of draught/smoke seals (Euroclass A1) - leaf or frame fitted - Increase

Figure A.34 b) - Dimension of draught/smoke seals (Euroclass A1) - leaf or frame fitted - Decrease

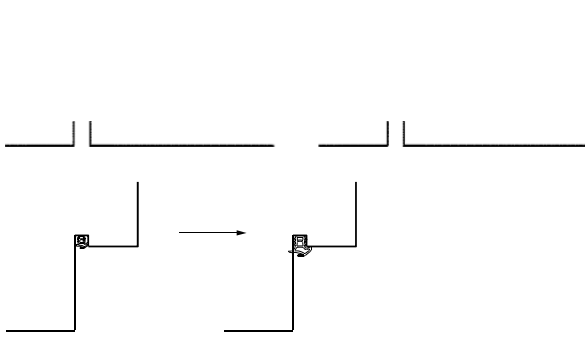

Figure A.35 a) - Dimension of draught/smoke seals (< Euroclass A1) - leaf or frame fitted
- Increase (two examples shown)

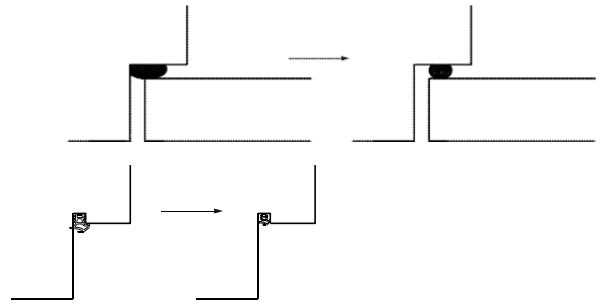

Figure A.35 b) - Dimension of draught/smoke seals (< Euroclass A1) - leaf or frame fitted
- Decrease (two examples shown)

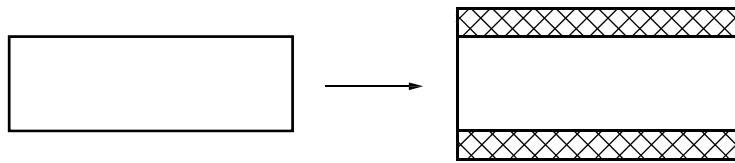

Figure A.36 - Decorative laminates on the face (on leaf or frame) - Add

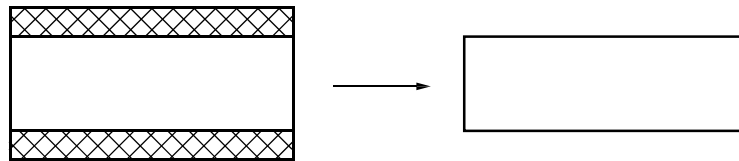

Figure A.37 - Decorative laminates on the face (on leaf or frame) - Remove

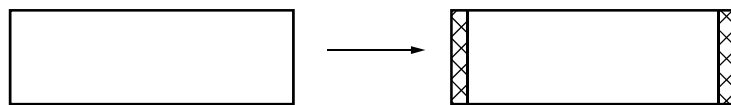

Figure A.38 - Decorative laminates on the edges (on leaf or frame) - Add

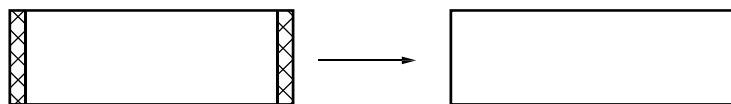

Figure A.39 - Decorative laminates on the edges (on leaf or frame) - Remove

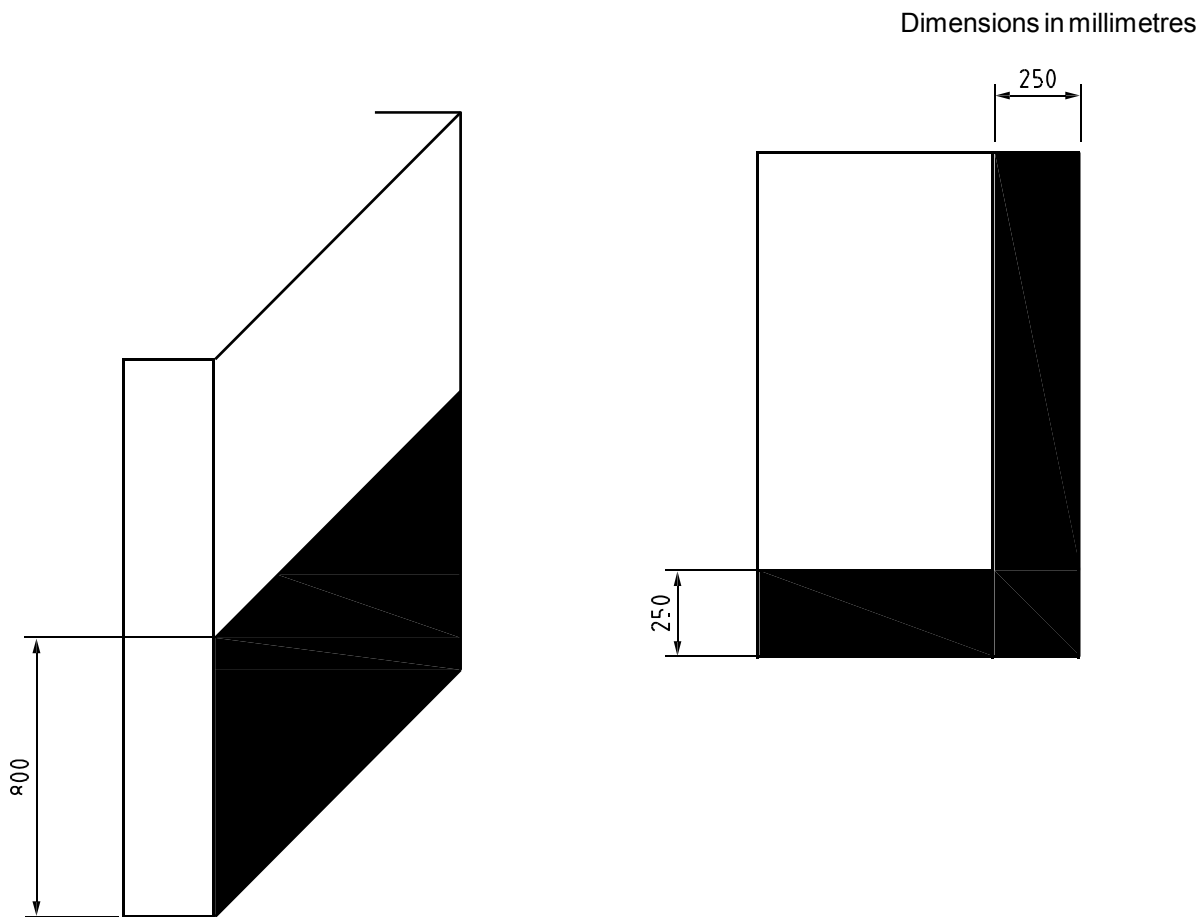
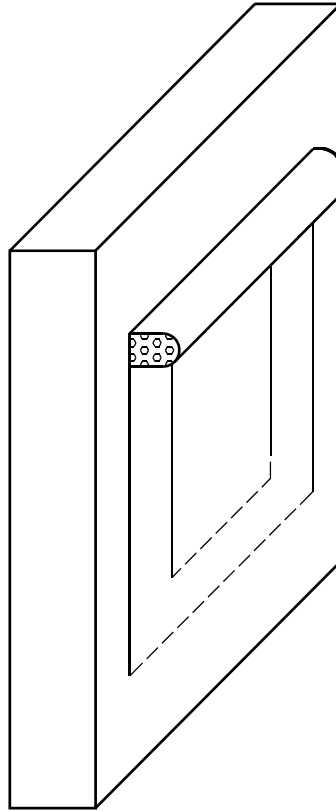

Figure A.40 - Protective elements - face fixed (kick plates/push plates/armour plates) - Add



1 moulding/profile

Figure A.41 - Mouldings/profiles -

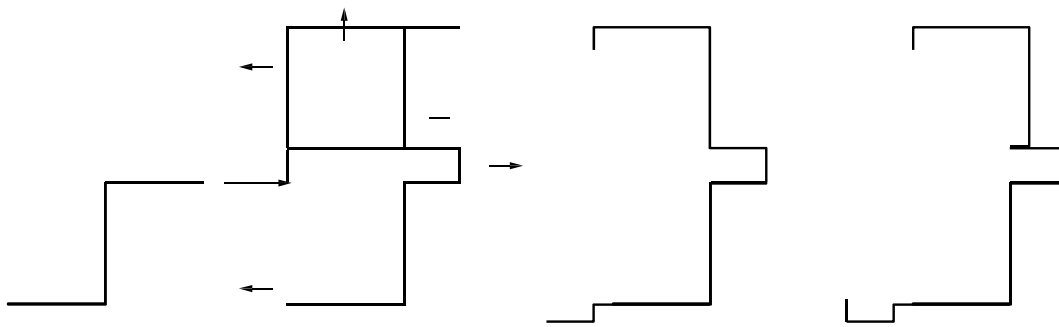

Figure A.43 - Overall dimensions and shape - Increase

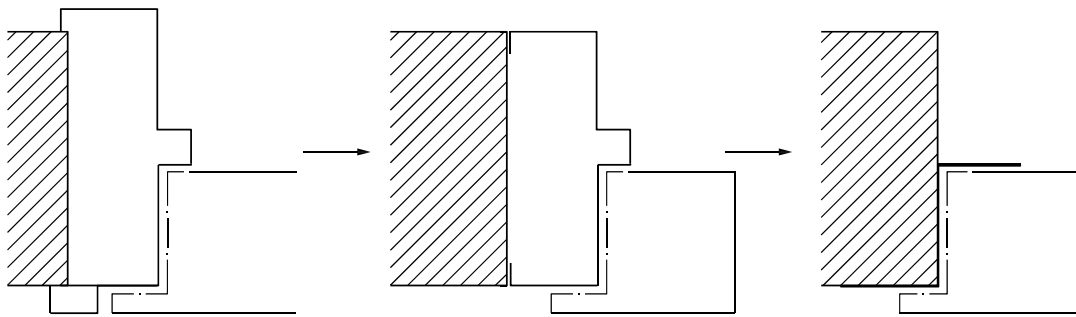

Figure A.44 - Overall dimensions and shape - Decrease

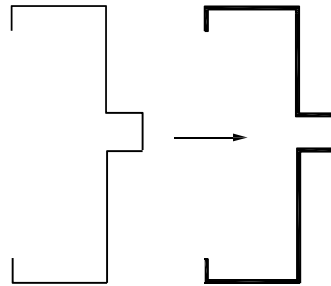

Figure A.45a) - Thickness of metal - Increase

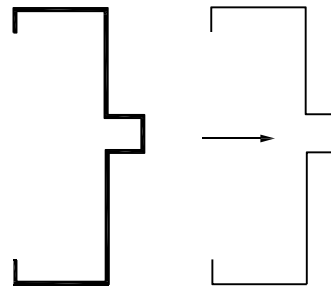

Figure A.45b) - Thickness of metal - Decrease

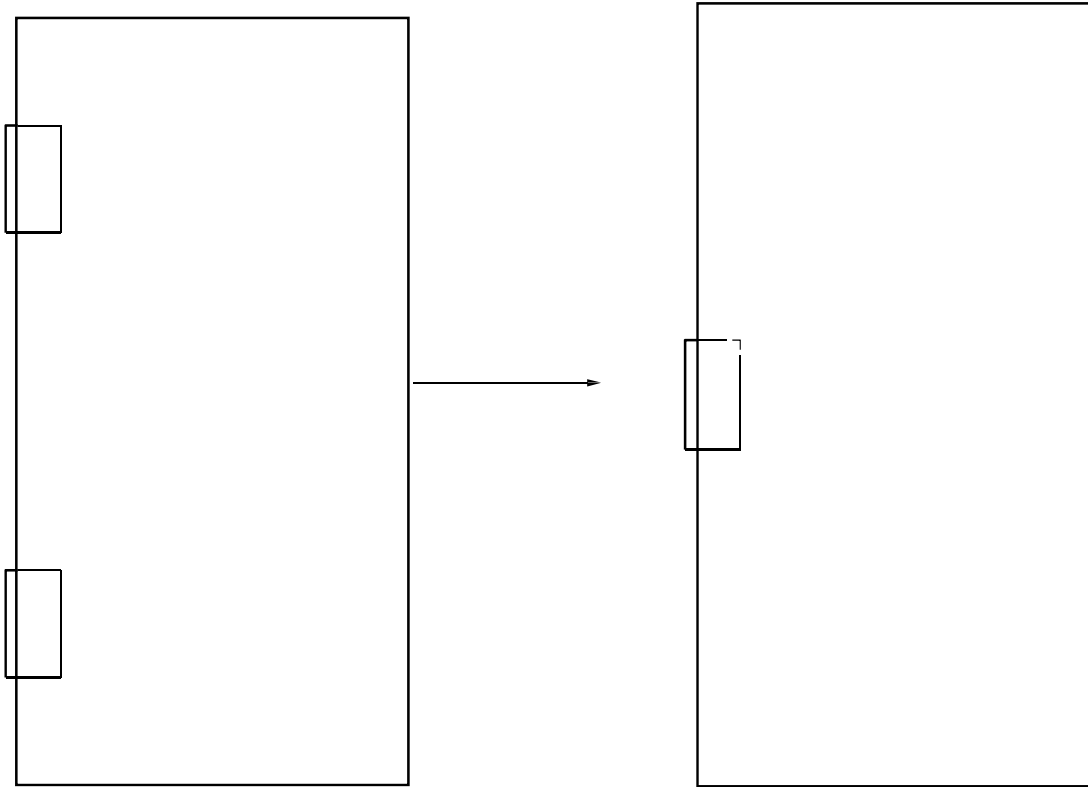

Figure A.47 - Number of latches/locks and strike plates - Decrease

Dimensions in millimetres

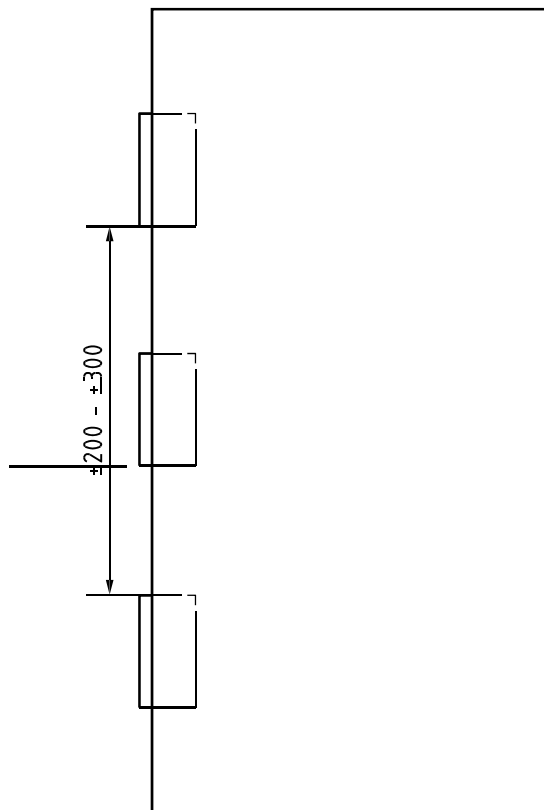

Figure A.48 - Position of single latch/lock and strike plate - Alternative

Dimensions in millimetres

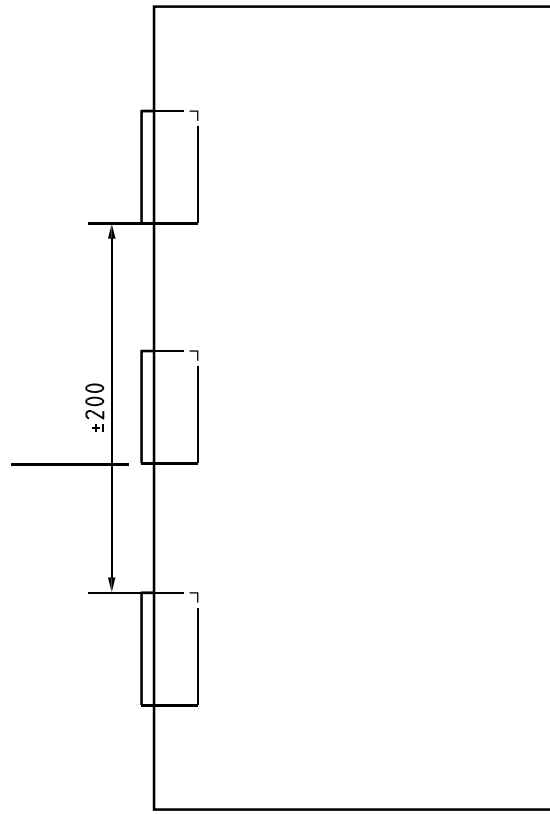

Figure A.49 - Position of multiple latches/locks/strike plates (with or without connecting rods) - Alternative

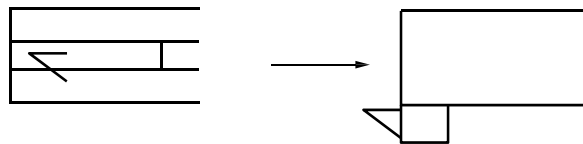

Figure A.50 a) - Latches/locks - Exchange internal for external

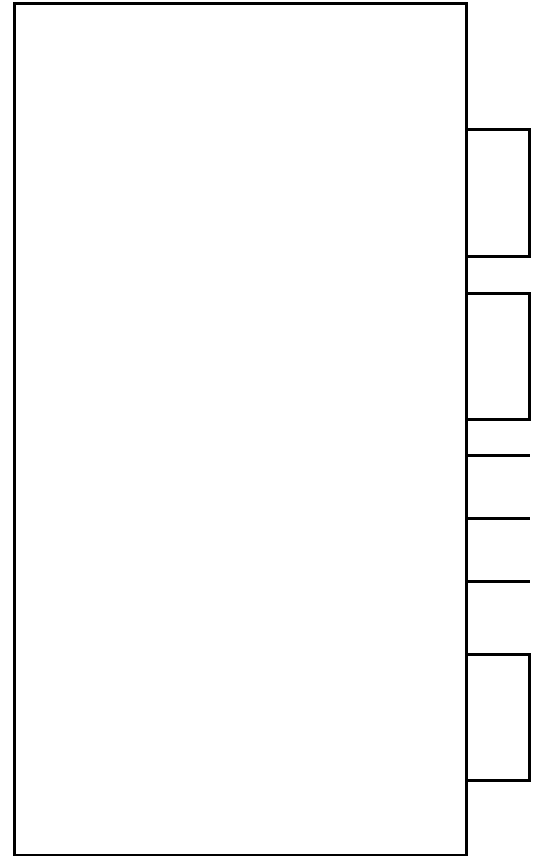
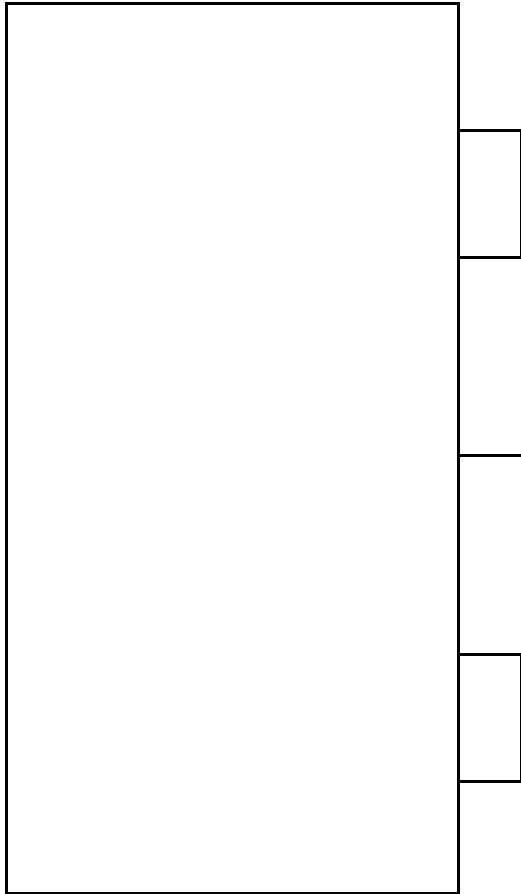

Figure A.50 b) - Latches/locks - Exchange external for internal

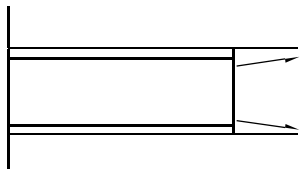

Figure A.51 - Dimension of dog bolts - Increase

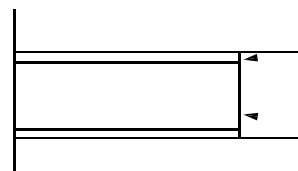
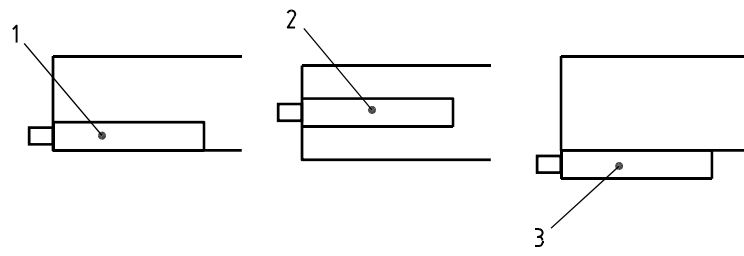

Figure A.52 - Dimension of dog bolts - Decrease



- 1 flush
- 2 internal mounted
- 3 surface mounted

Figure A.53 - Bolts (flush, internal and surface mounted) - Add

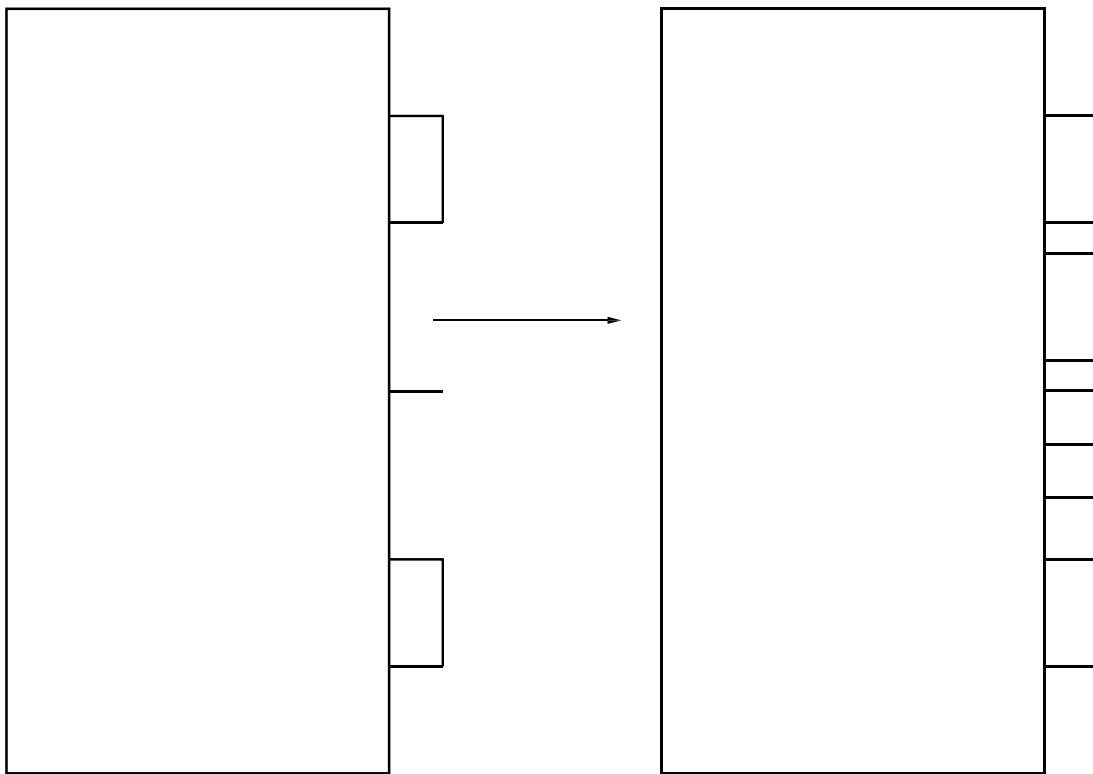

Figure A.54 a) - Number of hinges/dog bolts - Increase

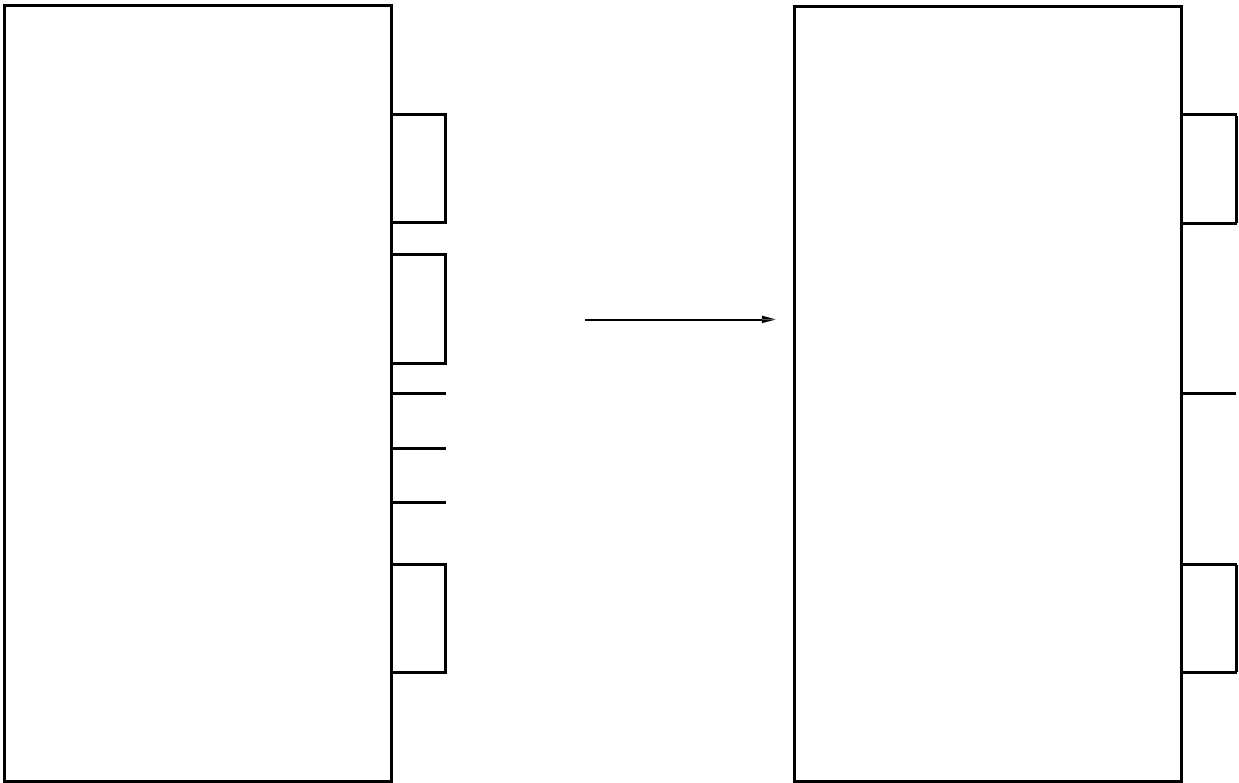

Figure A.54b - Number of hinges/dog bolts - Decrease

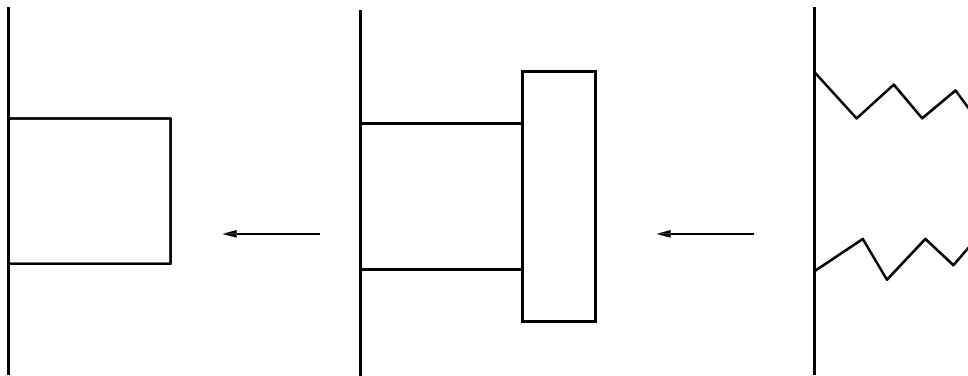

Figure A56 - Type of dog bolts - Alternative material/type/shape

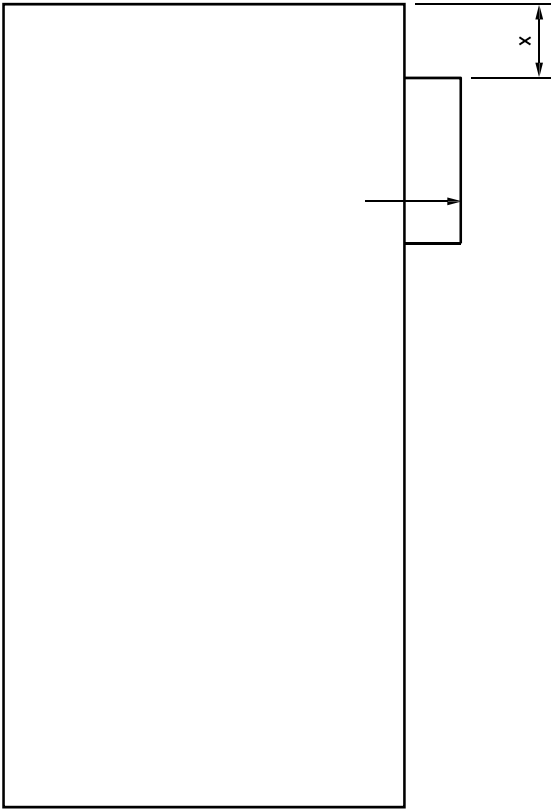

Figure A.57 - Distance from top of upper hinge to top of door (x) - Increase/Decrease

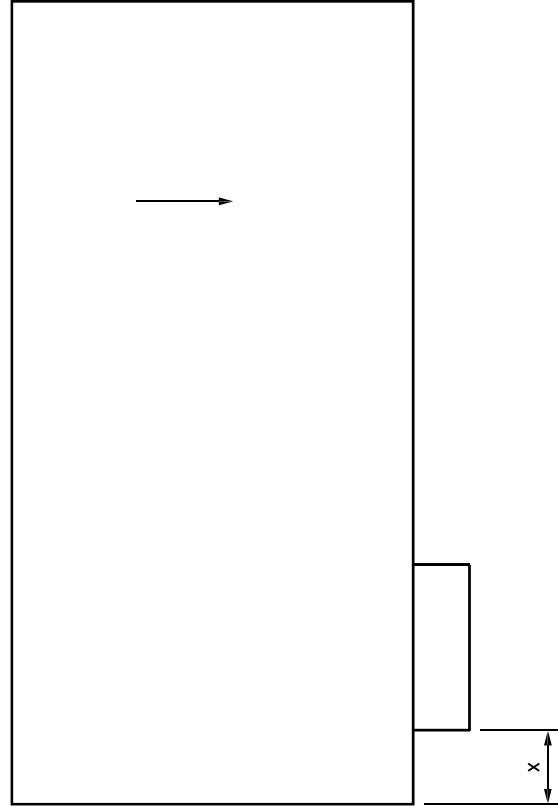
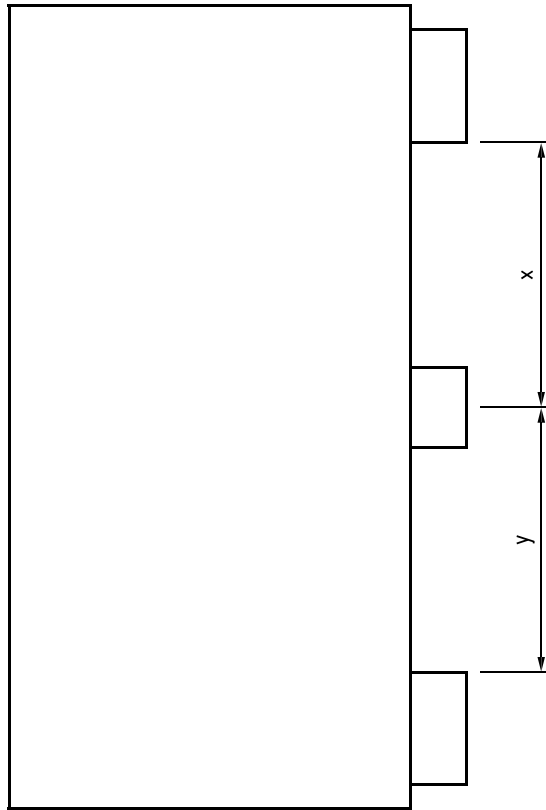
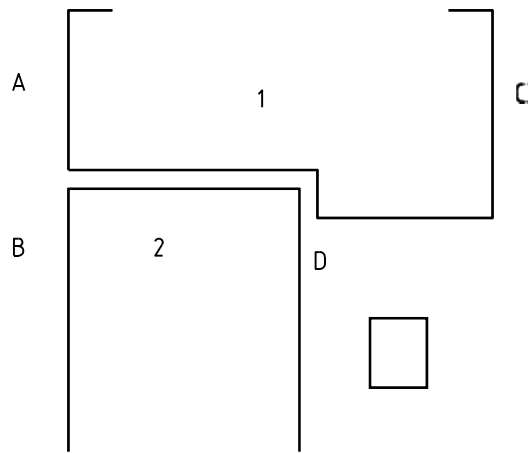

Figure A.58 - Distance from bottom of lower hinge to bottom of door (x) - Increase/Decrease



x and y distance between movement restrictors

Figure A.59 - Distances between top and bottom hinges and intermediate movement restrictors - Increase/Decrease



- 1 frame header
- 2 door leaf
- A, B, C, D alternative locations for face fixed door closer

Figure A.60 - Face fixed door closer - Alternative fitting positions

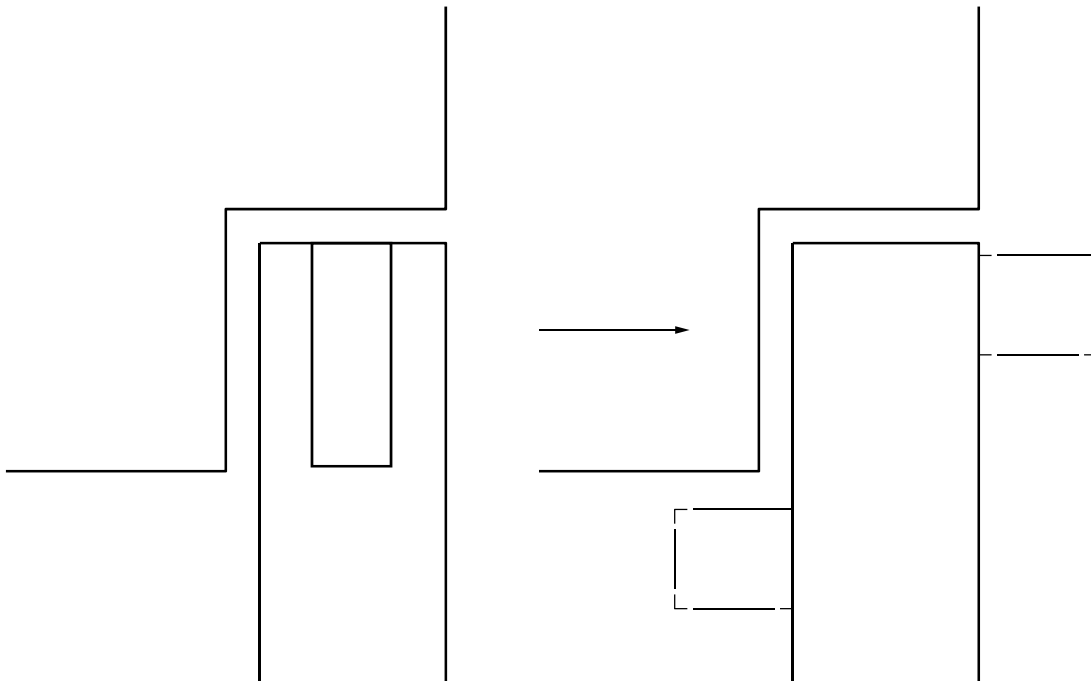

Figure A.61 - Door closer - Change of location (concealed for face mounted)

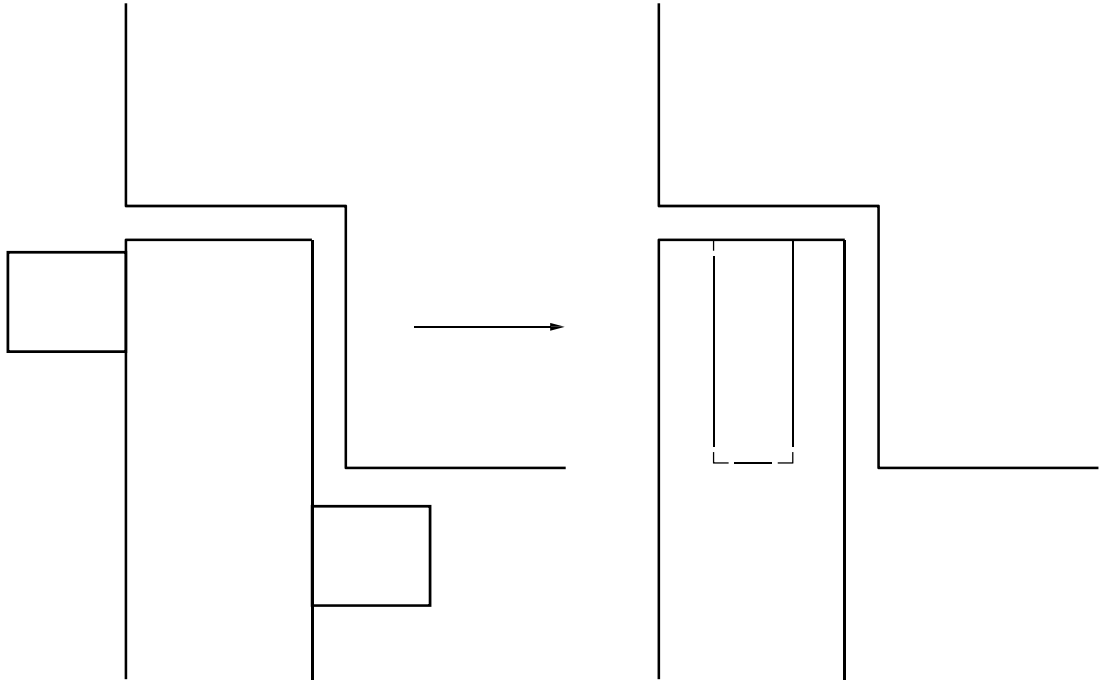
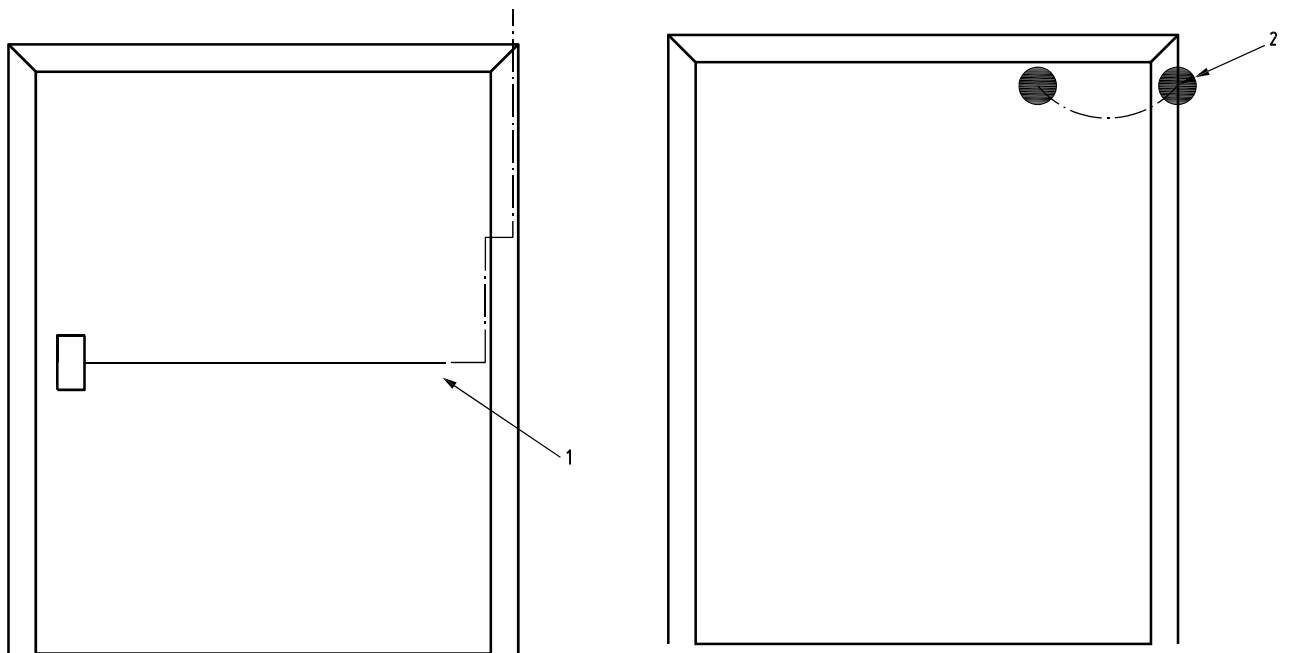
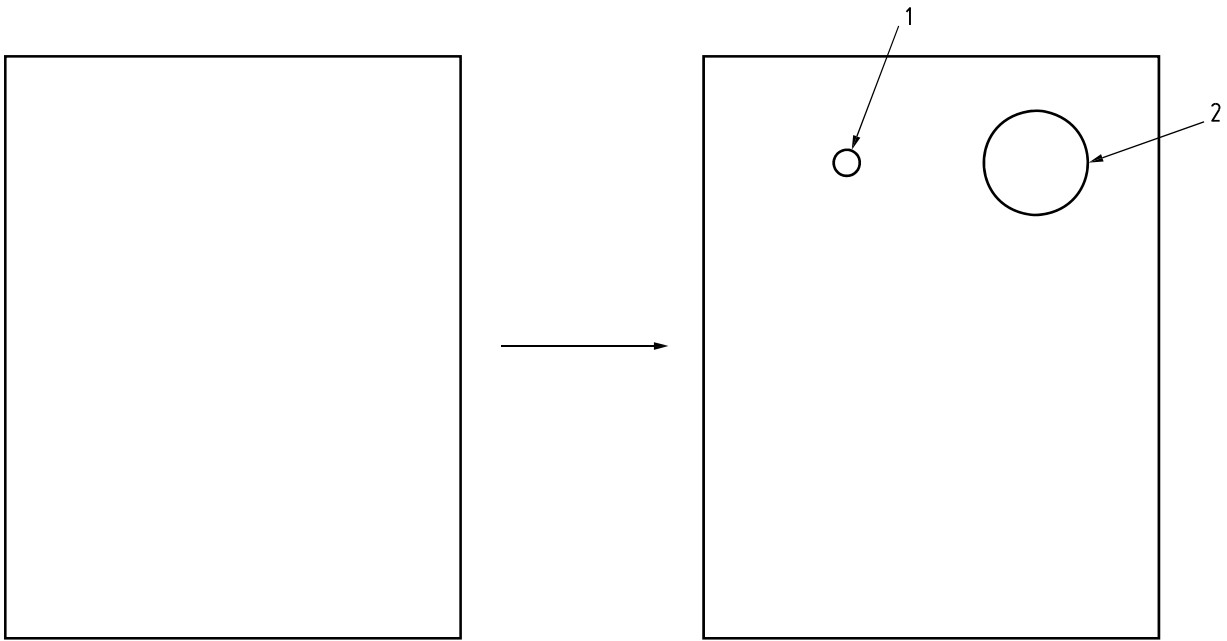

Figure A.62 - Door closer - Change of location (face mounted for concealed)



- 1 internal
- 2 external

Figure A.63 - Power cable and protective conduits for electric locks (fitted in the door leaf or frame)
- Add (two examples shown)



- 1 spy hole
- 2 key tube

Figure A.64 - Spy holes/key tubes - Add

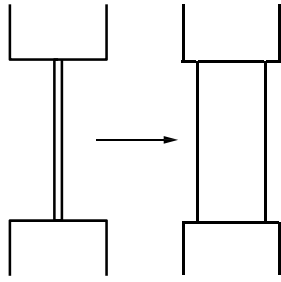

Figure A.66 a) - Thickness of glass - Increase

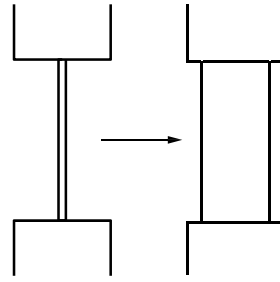

Figure A.66 b) - Thickness of glass - Decrease

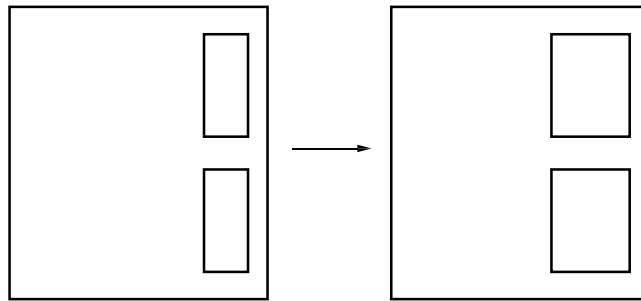

Figure A.67 - Dimensions of each glazed aperture - Increase

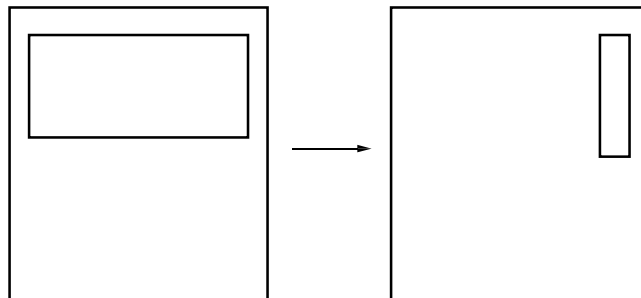

Figure A.68 - Dimensions in each glazed aperture - Decrease

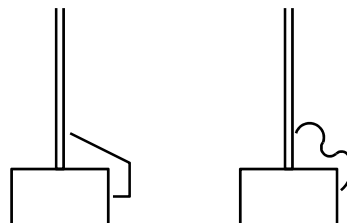
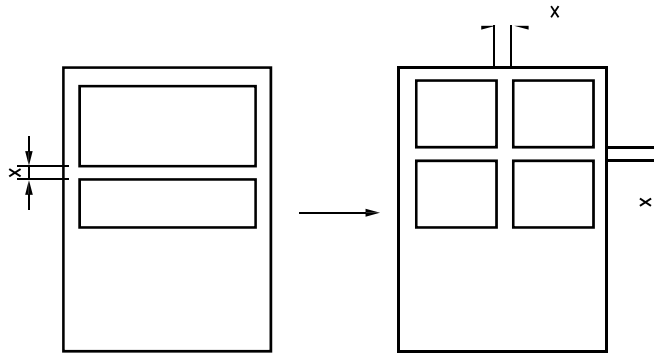

Figure A.69 - Decorative capping - Add or exchange



x distance between glazed apertures

Figure A.70 - Number of glazed apertures - Increase

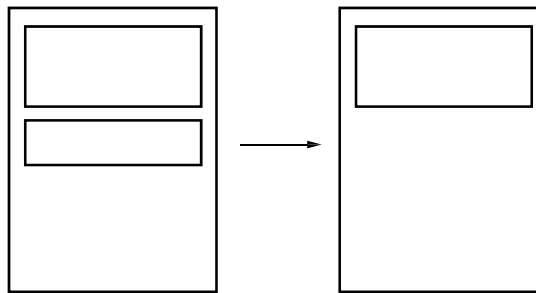

Figure A.71 - Number of glazed apertures - Decrease

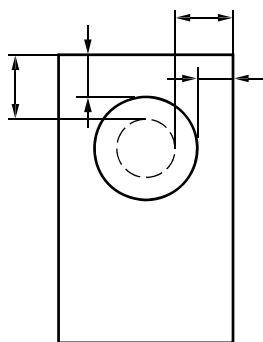

Figure A.72 - Smallest tested distance between the edge of glazing and the perimeter of the door leaf/panel - Increase

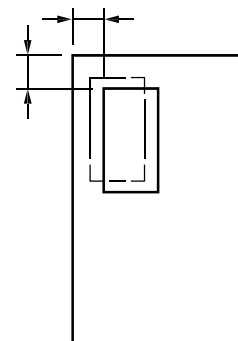

Figure A.73 - Smallest tested distance between the edge of glazing and the perimeter of the door leaf/panel - Decrease

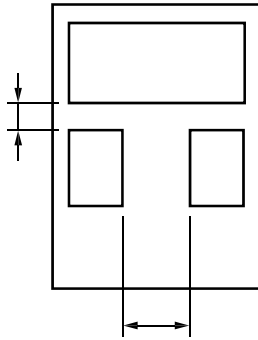
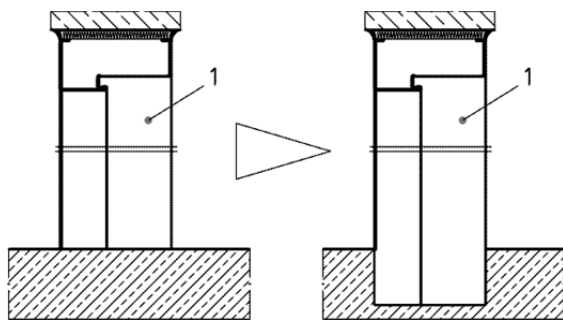

Figure A.74- Distance between glazed apertures - Decrease



Key

1 frame

Figure A.75 a) - Fixing to floor - Cleated to sunk

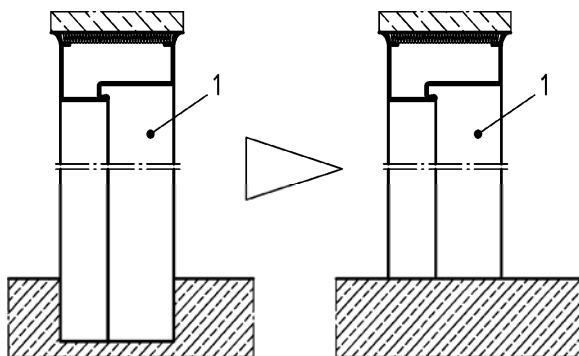

Key

1 frame

Figure A.75 b) - Fixing to floor - Sunk to cleated

Dimension in millimetres

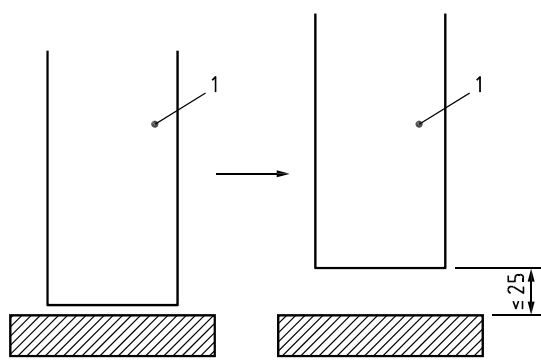

1 door leaf

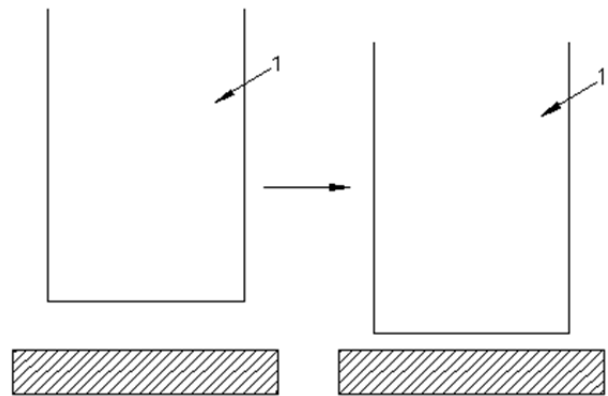

1 door leaf

Figure A.76 - Gap between door leaf and floor
- Increase

Figure A.77 - Gap between door leaf and floor
- Decrease

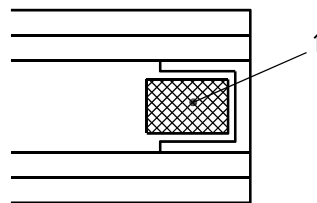

1 strengthening component

Figure A.78 - Standard flexible supporting construction - Strengthening

Table B1 Arrangements for doorsets incorporating side and/or over panels

Table B.1 - Permissible Variations for Panel Arrangements with Transom Panels

Allows																									
	1	2	3	4	5	6	7	8	9	10	11	12	13	14	15	16	17	18	19	20	21	22	23	24	
Tested arrangement	1	x	x	x	x	x	x	x	x	x	x	x	x	x	x	x	x	x	x	x	x	x	x	x	
	2	-	x	-	x	x	x	-	x	x	x	x	-	x	x	x	-	x	-	x	x	x	x	x	
	3	x	x	x	x	x	x	x	x	x	x	x	x	x	x	x	x	x	x	x	x	x	x	x	x
	4	-	x	-	x	x	x	-	x	x	x	x	x	-	x	x	x	-	x	-	x	x	x	x	x
	5	-	x	-	x	x	x	-	x	x	x	x	x	-	x	x	x	-	x	-	x	x	x	x	x
	6	-	-	-	-	-	x	-	x	x	x	x	x	-	-	-	x	-	x	-	x	x	x	x	x
	7	-	-	-	-	-	-	x	x	x	-	-	x	x	x	x	x	x	x	x	x	x	x	x	x
	8	-	-	-	-	-	-	-	x	x	-	-	x	-	x	x	x	-	x	-	x	x	x	x	x
	9	-	-	-	-	-	-	-	-	x	-	-	-	-	-	-	-	-	-	-	-	x	-	-	-
	10	-	-	-	-	-	-	-	-	-	x	x	x	-	-	-	-	-	-	-	-	-	x	x	x
	11	-	-	-	-	-	-	-	-	-	x	x	x	-	-	-	-	-	-	-	-	-	x	x	x
	12	-	-	-	-	-	-	-	-	-	-	-	x	-	-	-	-	-	-	-	-	-	x	x	x
	13	-	-	-	-	-	-	x	x	x	-	-	x	x	x	x	x	x	x	x	x	x	x	x	x
	14	-	-	-	-	-	-	-	x	x	-	-	x	-	x	x	x	-	x	-	x	x	x	x	x
	15	-	-	-	-	-	-	-	x	x	-	-	x	-	x	x	x	-	x	-	x	x	x	x	x
	16	-	-	-	-	-	-	-	x	x	-	-	x	-	-	-	x	-	-	-	-	x	x	x	x
	17	-	-	-	-	-	-	x	x	x	-	-	-	x	x	x	x	x	x	x	x	x	x	x	x
	18	-	-	-	-	-	-	-	x	x	-	-	x	-	x	x	x	-	x	-	x	x	x	x	x
	19	-	-	-	-	-	-	x	x	x	-	-	-	x	x	x	x	x	x	x	x	x	x	x	x
	20	-	-	-	-	-	-	-	x	x	-	-	x	-	x	x	x	-	x	-	x	x	x	x	x
	21	-	-	-	-	-	-	-	-	x	-	-	-	-	-	-	-	-	-	-	-	x	-	-	-
	22	-	-	-	-	-	-	-	-	-	-	-	x	-	-	-	-	-	-	-	-	-	x	x	x
	23	-	-	-	-	-	-	-	-	-	-	-	x	-	-	-	-	-	-	-	-	-	x	x	x
	24	-	-	-	-	-	-	-	-	-	-	-	x	-	-	-	-	-	-	-	-	-	x	x	x

Table B.2 - Permissible Variations for Panel Arrangements with Flush Over Panels

		Allows														
Tested arrangement		1	2	3	4	5	6	7	8	9	10	11	12	13	14	
	1	x	x	x	x	x	x	x	x	x	x	x	x	x	x	x
	2	x	x	x	x	x	x	x	x	x	x	x	x	x	x	x
	3	-	-	x	x	x	x	x	x	-	-	x	x	x	x	
	4	-	-	-	x	-	-	-	x	-	-	-	-	-	-	
	5	-	-	x	x	x	x	x	x	-	-	x	x	x	x	
	6	-	-	x	x	x	x	x	x	-	-	x	x	x	x	
	7	-	-	x	x	x	x	x	x	-	-	x	x	x	x	
	8	-	-	-	x	-	-	-	x	-	-	-	-	-	-	
	9	-	-	-	-	-	-	-	-	x	x	x	x	x	x	
	10	-	-	-	-	-	-	-	-	x	x	x	x	x	x	
	11	-	-	-	-	-	-	-	-	-	-	x	x	x	x	
	12	-	-	-	-	-	-	-	-	-	-	x	x	x	x	
	13	-	-	-	-	-	-	-	-	-	-	x	x	x	x	
	14	-	-	-	-	-	-	-	-	-	-	x	x	x	x	

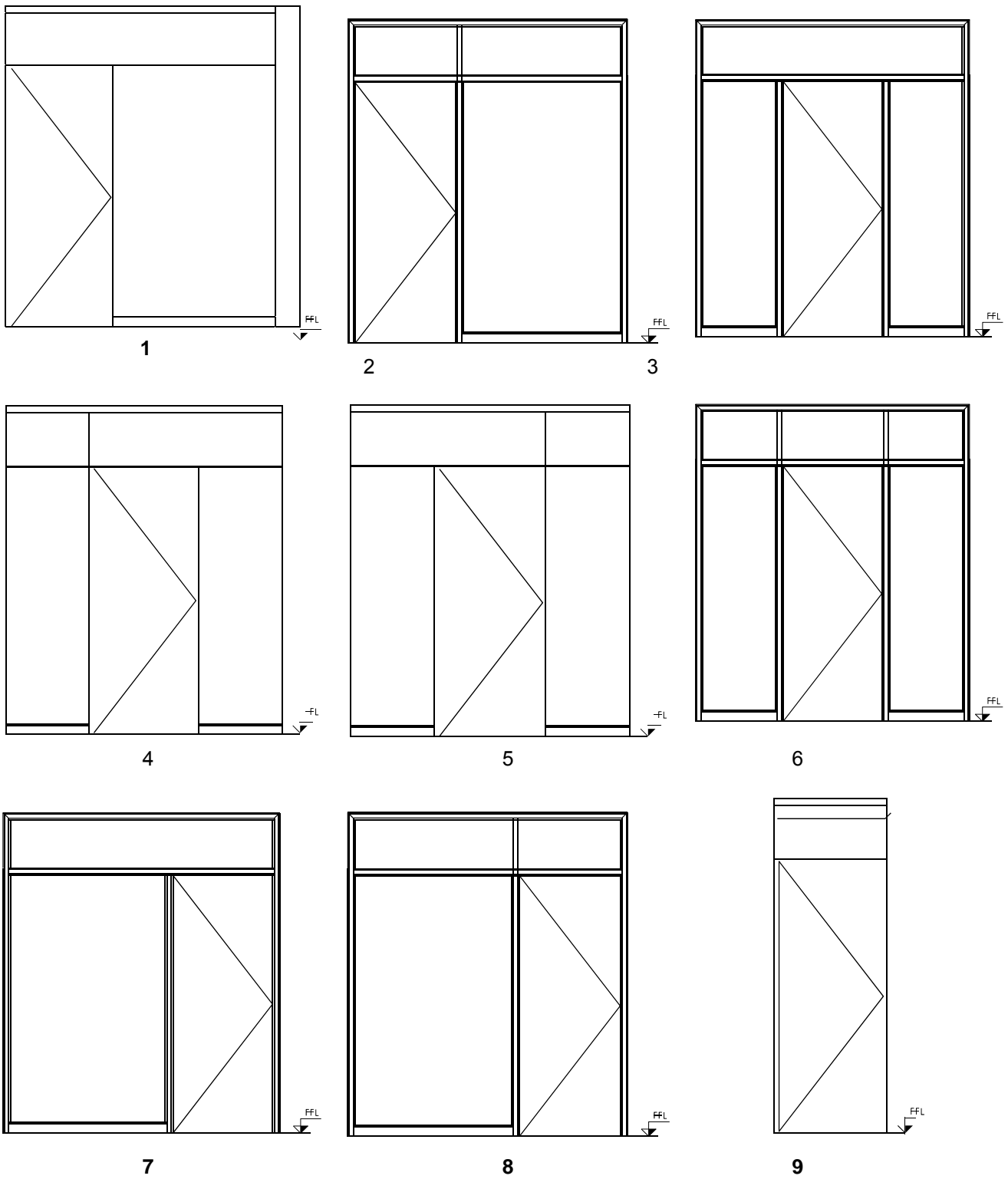

Figure B.1 - Side/transom panel arrangement (Additional or variations of alternative arrangements)

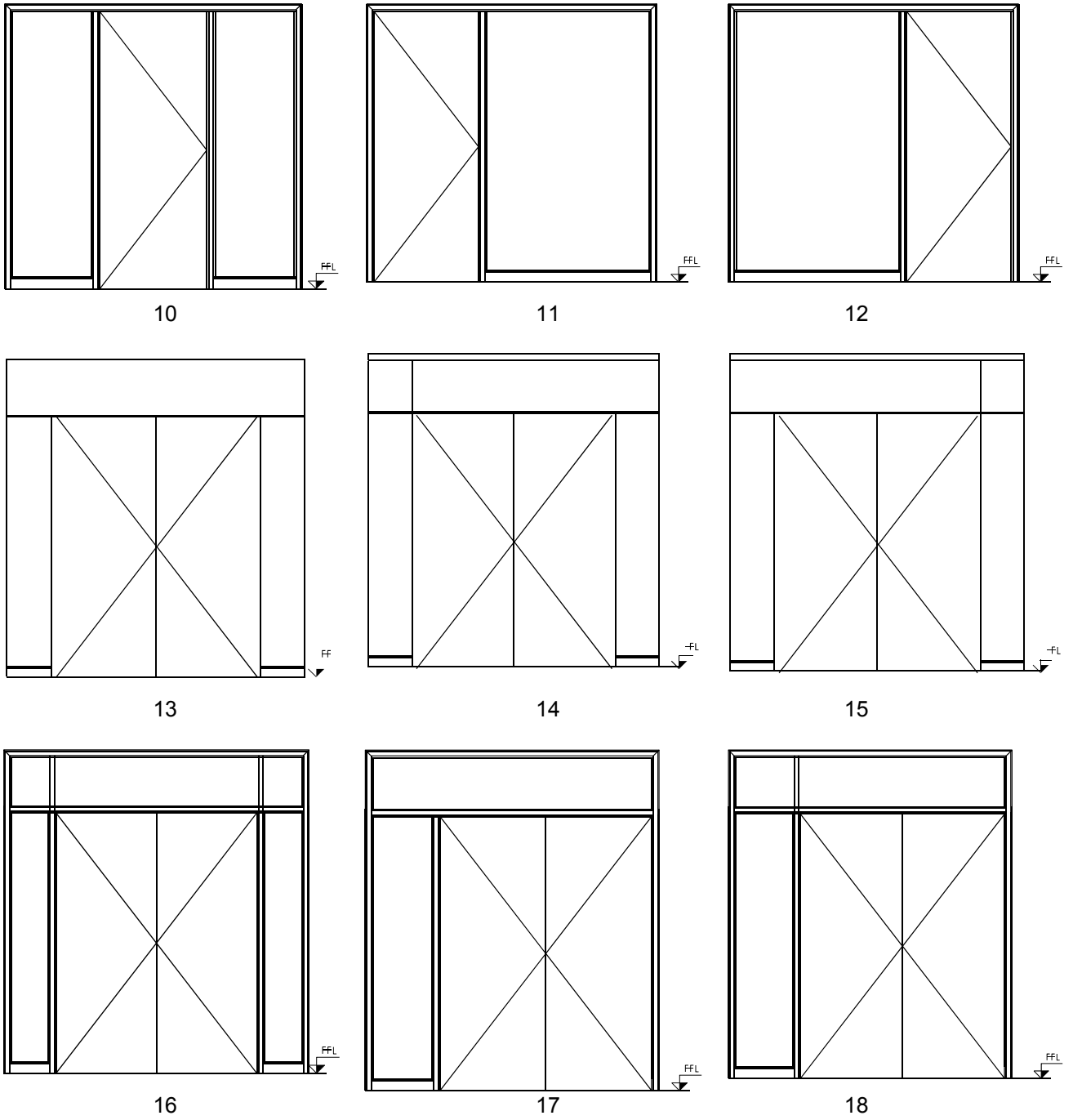
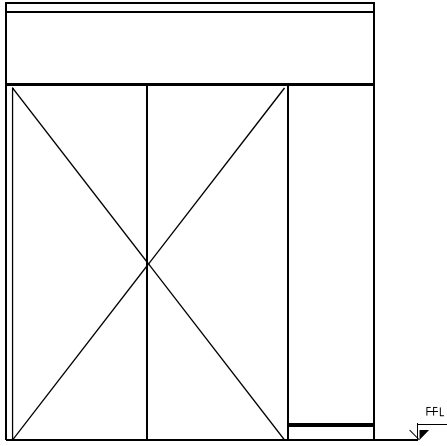
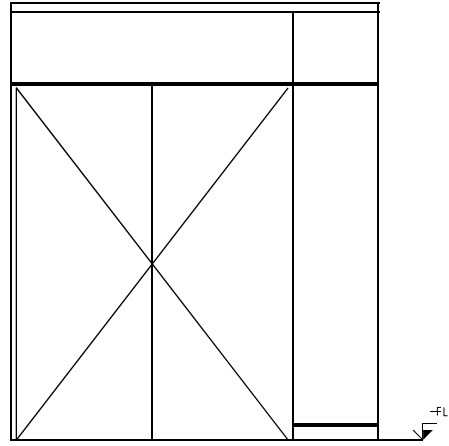

Figure B.1 - Side/transom panel arrangement (Additional or variations of alternative arrangements)
 - continued



19



20

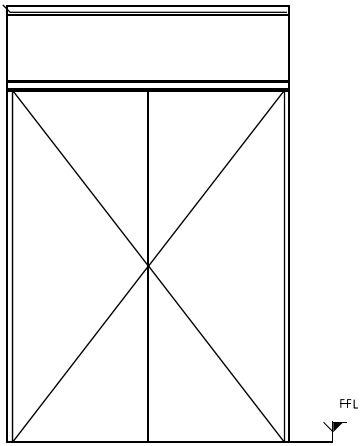

21

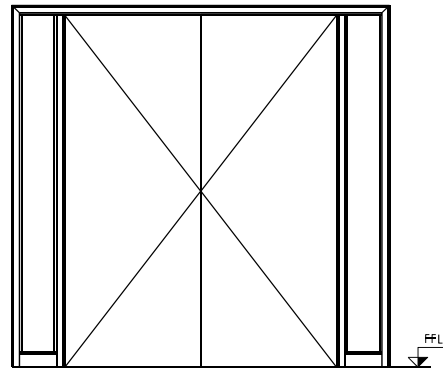

22

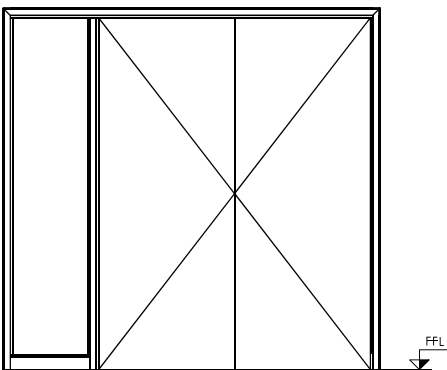

23

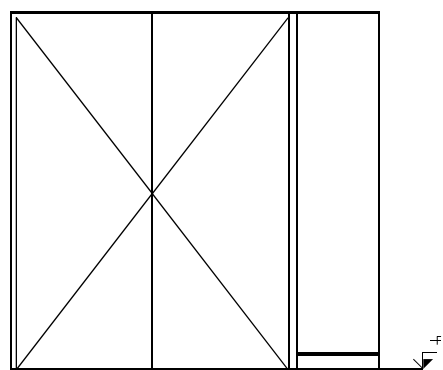

24

Figure B.1 - Side/transom panel arrangement (Additional or variations of alternative arrangements)
- concluded

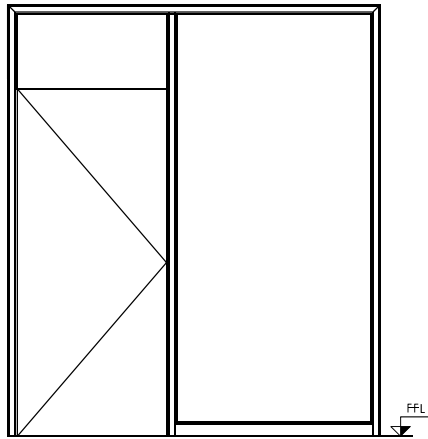

1

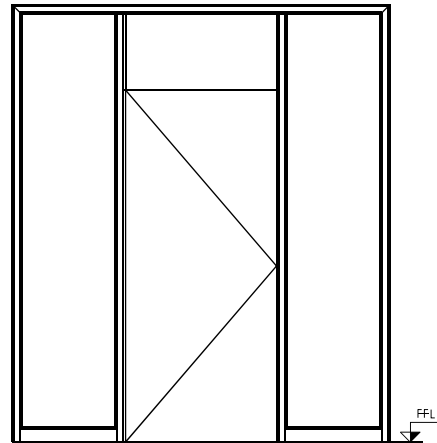

2

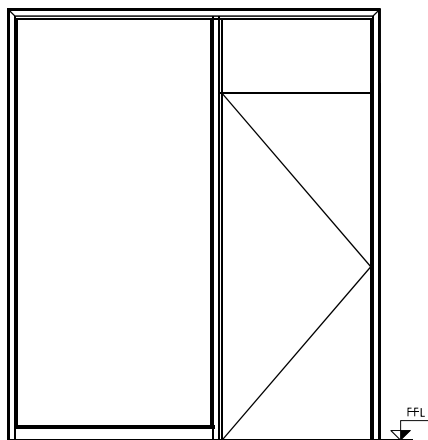

3

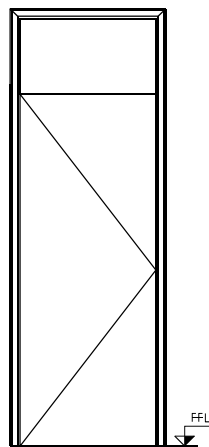

4

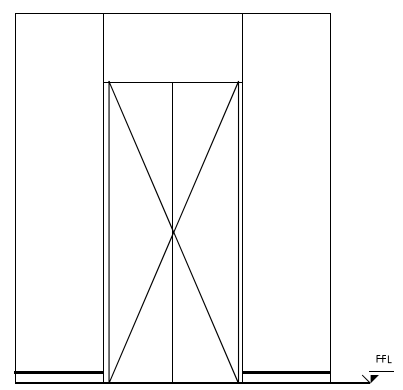

5

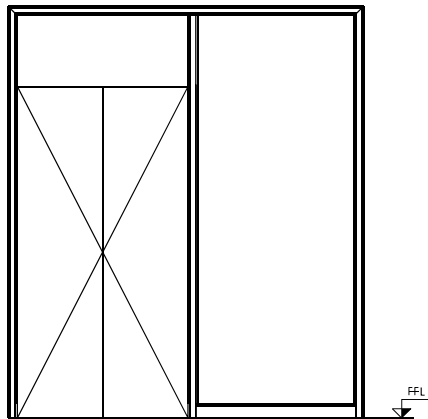

6

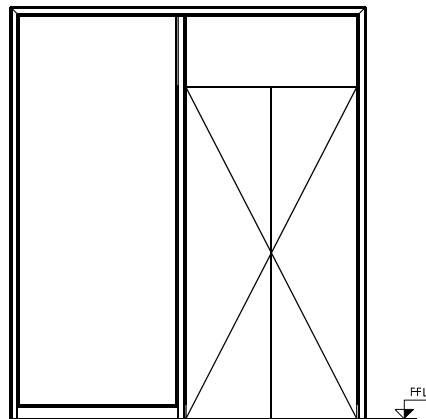

7

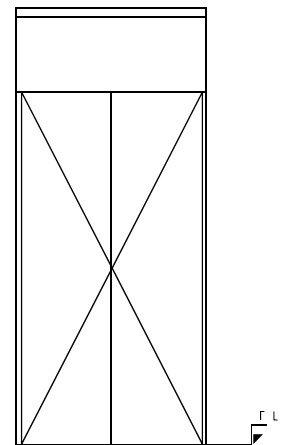

8

Figure B.2 - Side/transom panel arrangement (Additional or variations of alternative arrangements)

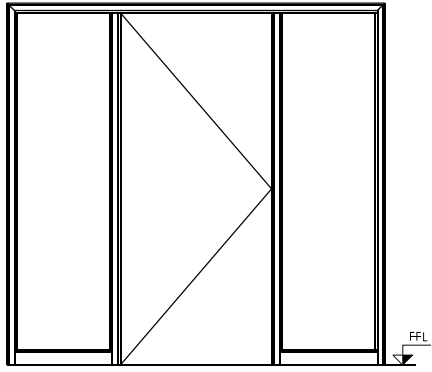

9

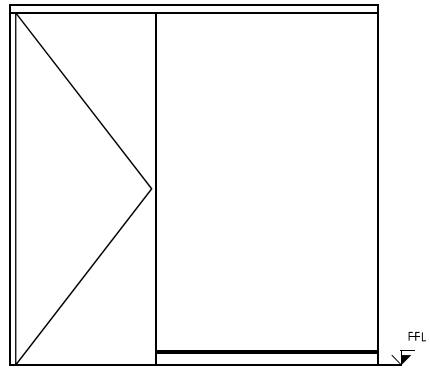

10

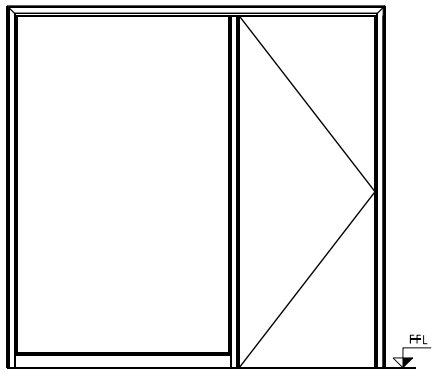

11

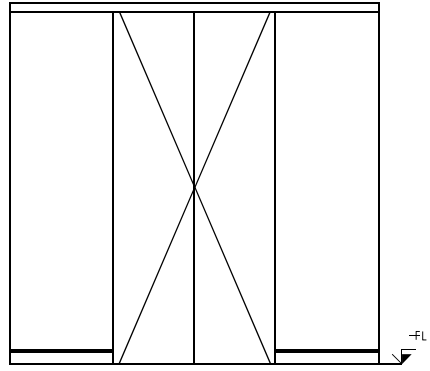

12

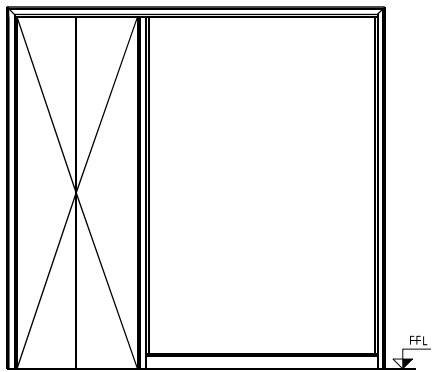

13

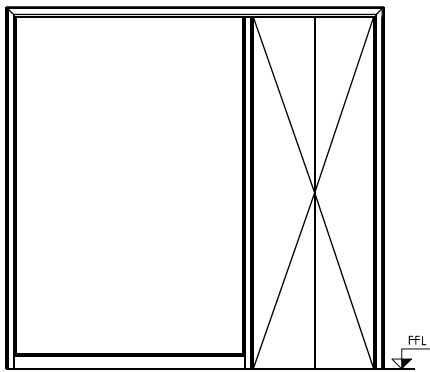

14

Figure B.2 - Side/transom panel arrangement (Additional or variations of alternative arrangements)
- concluded

Part C

Figures

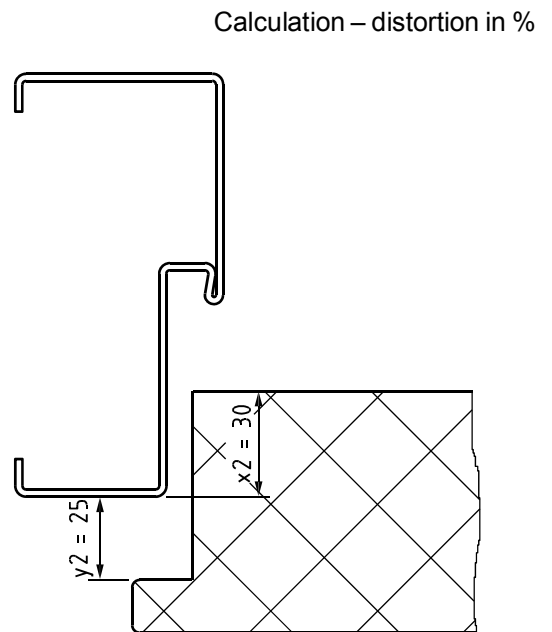
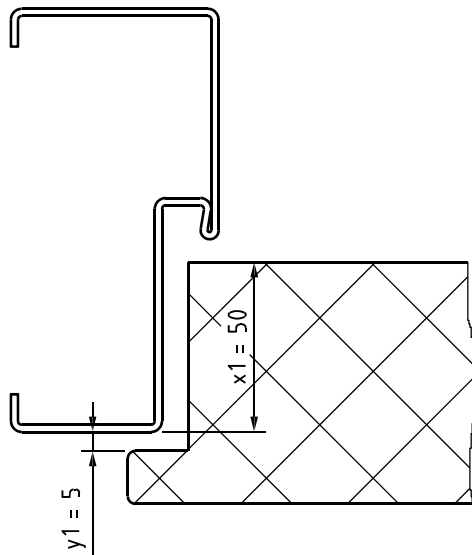

Key

X1 50 mm effective rebate depth before the test

X2 30 mm effective rebate depth after the test

This means that there was an absolute movement of 20 mm; according to the formula below this movement (distortion) is equivalent to 40 %:

$$20/50 \times 100 = 40 \% \text{ (60 \% of the initial value is left)}$$

Level of distortion according to prEN 15269-2 - medium

Figure C - Example effective rebate depth

Annex B – Extended application smoke control

1. General

Annex B covers hinged and pivoted steel doorsets of single or double-leaf construction and prescribes the methodology for extending the application of test results obtained from test(s) conducted in accordance with EN 1634-3.

Before there can be any consideration for extended application the doorset shall have been tested in accordance with EN 1634-3 to achieve a test result which could generate a classification in accordance with EN 13501-2 at least equal to the classification subsequently required from extended application considerations.

Subject to the completion of the appropriate test or tests, the extended application may cover Ambient Temperature Smoke Control (S_a) and Medium Temperature Smoke Control (S_m) classifications and all or some of the following variations:

- glazed elements,
- side, transom or overpanels;
- items of building hardware;
- decorative finishes;
- intumescent, smoke, draught or acoustic seals;
- alternative supporting construction(s).

2 Determination of the field of extended application

Before there can be any consideration for extended application the doorset shall have been tested and classified in accordance with EN 1634-3 and EN 13501-2 respectively in order to establish a classification for the doorset.

A review of the doorset construction parameters can indicate that one or more characteristics may be improved by a particular parameter variation. All evaluations shall be made on the basis of retaining the classifications obtainable from testing to EN 1634-3, including those lower than the test duration. However, this shall never lead to an increased classification for any specific parameter beyond that achieved during any one test unless specifically identified in the relevant Construction Parameter Variation tables.

All evaluations shall be made on the basis of retaining the classification obtained from testing to EN 1634-3.

If, by following the ensuing procedure, any part of the classification cannot be achieved by extended application rules that part of classification shall be omitted from the subsequent extended application report and classification report.

Identify the variations from the original test specimen(s) which are required to be covered by an extended application report.

Locate the variations in the appropriate parameter variation by reference to columns (1) and (2) of table A.

Review the type of classification to be retained from column (3) of table A and establish from the contents of column (4) of table A whether any extended application is available without the need for further testing.

Where this is deemed to be possible this can be recorded in the extended application report together with any appropriate restrictions and the stated rules from column (4) in Table A.

Where the variations required can only be achieved from additional testing according to column (5), the additional test can be made on a similar specimen type to the original test against which the extended application is sought. Alternatively, column (5) in table A identifies an option for alternative testing and relevant test parameters.

3 Procedure for maximum field of extended application

It is possible to provide a limited field of extended application from the results of a single test. However, where a manufacturer intends to produce a range of doors incorporating single doors and also double doors with or without glazing, with alternative elements of building hardware, etc., it is recommended that careful consideration is given to the complete range of doorset designs and options in order to minimise the testing required before testing commences.

Establish all the parameter variations which are required to be part of the product range.

Select specimens for the first tests in the series to ensure that the most important parameter variations for the manufactured products are covered.

Complete the first test or a series of tests and prepare a field of direct application from the results of the test(s).

Establish which of the original desired parameter variations have not been covered by the direct application and report.

Identify these parameter variations in table A and establish where an extended application is possible without further testing.

Record this for the extended application report together with any restrictions and rules given in column (5) in table A.

Evaluate which, if any, of the desired parameter variations have not been covered by the field of direct application or the initial field of extended application derived from chapter 3.

Select the required outstanding parameter variations from column (1) and column (2) of table A and observe from column (5) in table A which are the most appropriate weakest specimen options for further testing.

If the complete selection of required parameter variations has not been covered by the tests as listed above, then an appropriate test or tests may be carried out with the additional product variations incorporated.

4. Interpretation of test results

In order to maximise the field of extended application, it is important that the test reports shall record details of any failure throughout the duration of the test.

Where a series of tests have been conducted, the field of extended application shall be based on the lowest performance achieved from the complete series of tests unless excessive leakage has been attributed to one or more specific construction parameter variation.

Where it has been possible, to identify leakage due to a specific parameter, the extended application for all other construction parameter variations can be based on the performance achieved after isolating the parameter with excessive leakage.

5. Construction parameter variations

Table A is designed to provide rules for the creation of extended application reports by experts in the field of smoke control testing of hinged and pivoted doorsets.

Table A shall only be used to evaluate a field of extended application when at least one positive smoke control test to EN 1634-3 has resulted in a classification according to EN 13501-2.

The first two columns of table A identify possible variations to the construction details of the specimen tested.

The type of classification, referred to as performance characteristic in Column (3) of table A, achieved from the test can be identified from the 'Performance characteristic' section of table A column (3) as Ambient Smoke Control (S_a) and Medium Temperature Smoke Control (S_m) as derived from EN 13501-2.

The effect of the change in each parameter is evaluated for each characteristic in table A column (3) under

S_a for Ambient temperature and S_m for Medium temperature.

Where symbols are used these relate to the following definitions:

- a) < - forecast is a worse performance;
- b) > - forecast is a better performance;
- c) = - forecast is no significant difference;
- d) \leq - forecast is a worse or equal performance;
- e) \geq - forecast is a better or equal performance;
- f) $\geq <$ - forecast unknown.

These evaluations lead to the judgement of the possibility of extending the field of application, the results of which are given in column (4) of table A.

Where additional tests are deemed to be necessary the type of specimen approved for incorporation of the changed parameter is defined in column (5) of table A. Where it is possible to use information from tests performed on one configuration for evidence on a different configuration, this allowance has been made in order to reduce the overall number of tests required for extended application evaluation (e.g. single action doorsets to double action doorsets).

In all cases following the evaluation, the relationship between the leaf and the frame (e.g. gaps) shall remain the same as shall the relationship between smoke seals and the faces and/or edges of the leaf (i.e. the contact between the edges of the smoke seal and the leaf face) shall not decrease, nor shall the contact between the smoke seal and the leaf edge.

Solid timber can be replaced by other solid timber of the same or higher density. Glued timber with solid pieces of min. 10 mm thickness may be used as solid timber. Composite wood products (e.g. Medium Density Fibreboard) may not be replaced with other materials or composites.

If after consideration of a specific variation, additional changes are required to be made to the specimen, these may be made providing the implications on other variations are also taken into account.

Table A - Construction parameter variations

Construction Parameter (1)	Variation (2)	Influence of variation on performance characteristic (3)		Possibility of extension (4)	Additional Evidence Required (5)	
		S_a	S_m			
A Door leaf						
In certain cases, the rules given in Section A are also appropriate to side and overpanels or the door frame; where this is the case it is clearly indicated in column (1). For double leaf doorsets, both leaves shall be of the same basic construction.						
A.1 General						
A.1.3	smoke seals (fitted at leaf to frame interface) - see Figure A.1	Location towards the frame rebate	≤	≤	Not possible without additional test	Test shall be of the required configuration.
A.1.4	smoke seals (fitted at leaf to frame interface) - see Figure A.2	Location away from the frame rebate	≤	≤	Not possible without additional test	Test shall be of the required configuration.
A.1.5	smoke seals (fitted in meeting edges)	Location change	≤	≤	Not possible without additional test	Test shall be of the required configuration.
A.1.6	smoke seals (fitted in leaf or frame)	Remove	<	<	Not possible without additional test	Test shall be of the required configuration.
A.1.14	Leaf edge rebate (to door leaf or panel – not at the meeting edges; see section A.2 for meeting edge parameters) - see Figure A.4	Add (added rebate shown shaded in drawings)	≥	≥	Possible providing the rebate does not lead to reduced compression on the seals	
A.1.15	Leaf edge rebate (to door leaf or panel – not at the meeting edges; see section A.2 for meeting edge parameters)	Remove	≤	≤	Not possible without additional test	The required detail shall be tested. Test can be single or double leaf.
A.1.17	Latched condition for single leaf or double leaf doorsets - see	Change in latching condition	>=<	<	Possible in line with the following relationship otherwise not possible without an additional test:	Additional test to include the required

Construction Parameter (1)	Variation (2)	Influence of variation on performance characteristic (3)		Possibility of extension (4)				Additional Evidence Required (5)
		S _a	S _m					
Figure A.5					tested without a latch/lock/bolt	tested with a latch/lock/bolt but unlatched	tested with a latch/lock/bolt, latched	latching condition
				extension to: without a lock/latch/bolt		possible	not possible	
				extension to: with lock/latch/bolt but unlatched	not possible		not possible	
				extension to: with a lock/latch/bolt, latched	not possible	possible		
				Additional latch/lock may be fitted providing there is specific evidence on the latch/lock identifying it will not affect the leakage.				
A.2 Meeting edge detail								
A.2.1	Meeting edge detail - see Figure A.6	Change in edge detail	≤	≤	Possible for S _a for rebated details shown in Figures A.6(a) and A.6(b) only otherwise not possible without additional test			Test shall be double leaf.
A.2.2	Astragal - see Figure A.6f)	Add	≥	≥	Possible			
A.2.3	Astragal - see Figure A.6f)	Remove	≤	≤	Not possible without additional test			Test shall be double leaf.
A.3 Size variations								
A.3.1	Size of leaf or panel (area, width, height)	Decrease	≥	≥	Possible			

Construction Parameter (1)	Variation (2)	Influence of variation on performance characteristic (3)		Possibility of extension (4)	Additional Evidence Required (5)
		S _a	S _m		
A.3.3 Thickness of the door leaf or panel	Increase	≥	≥	Possible	
A.3.4 Thickness of the door leaf or panel	Decrease	≤	≤	Not possible without an additional test	Required thickness of leaf or panel shall be tested.
A.4 Materials and constructions					
A.4.1 Density of core material of leaf or panel	Increase/decrease	≥	>=<	Possible for timber and steel based S _a doorsets and possible for S _m timber and steel based doorsets providing the increase/decrease is not greater than 50% otherwise not possible without an additional test	Test on required density of core material
A.4.2 Pattern of core material of leaf or panel – see Figure A.7	Increase number of pieces	=	>=<	Possible for S _a .	
				Possible for S _m doorsets by 50% providing the test included more than one joint. Possible also proportionately with a leaf/panel size increase For double leaf doorsets, the rule shall be applied to each leaf separately, otherwise not possible without additional test.	Test shall be on a leaf with the maximum number of required pieces.

Construction Parameter	Variation	Influence of variation on performance characteristic		Possibility of extension	Additional Evidence Required
		(3)			
(1)	(2)	S _a	S _m		
A.4.3 Pattern of core material of leaf or panel	Decrease number of pieces	=	>=<	Possible for S _a ,	Test shall be on a leaf with the minimum number of required pieces.
				Possible for S _m steel based doorsets providing the fixing technique is unchanged and possible for S _m timber based doorsets by up to 50% providing one joint in the core material remains. For double leaf doorsets, the rule shall be applied to each leaf separately, otherwise not possible without additional test.	
A.4.4 Number of layers of identical core material of leaf or panel	Increase number of layers	=	>=<	Possible for S _a .	Test shall be on a leaf with the maximum number of required layers.
				Possible for S _m doorsets up to 50% providing the test included more than one joint. For double leaf doorsets, the rule shall be applied to each leaf separately, otherwise not possible without additional test.	
A.4.5 Number of layers of identical core material of leaf or panel	Decrease number of layers	=	>=<	Possible for S _a ,	Test shall be on a leaf with the minimum number of required pieces
				Possible for S _m steel based doorsets providing the fixing technique is unchanged and possible for S _m timber based doorsets by up to 50% providing one joint in the core material remains. For double leaf doorsets, the rule shall be applied to each leaf separately, otherwise not possible without additional test.	
A.4.6 Type of core material in leaf or panel (single thickness or in combination of different layers)	Change of manufacturer (same basic product type)	=	=	Possible	
A.4.7 Type of core material in leaf or panel (single thickness or in combination of different layers)	Alternative composition of same basic product type	=	=	Possible	

Construction Parameter (1)	Variation (2)	Influence of variation on performance characteristic (3)		Possibility of extension (4)	Additional Evidence Required (5)
		S_a	S_m		
A.4.11 Type of adhesives used in leaf or panel	Change of supplier/manufacturer for identical composition	=	=	Possible	
A.4.12 Type of adhesives used in leaf or panel	Alternative composition	=	≤	Possible for S_a	Additional test to include the alternative adhesive
				Not possible for S_m	
A.4.13 Glued area (partially or fully glued)	Increase	≥	≥	Possible	
A.4.14 Glued area (partially or fully glued)	Decrease	≤	≤	Not possible	

Construction Parameter (1)	Variation (2)	Influence of variation on performance characteristic (3)		Possibility of extension (4)	Additional Evidence Required (5)
		S _a	S _m		
A.4.17 Cross-section dimension of perimeter framing elements in leaf or panel	Increase	≥	≥	Possible	
A.4.18 Cross-section dimension of perimeter framing elements in leaf or panel	Decrease	>=<	>=<	Possible for S _a . Possible for S _m providing the stiffness of the leaf is not reduced such that the resulting leaf will not distort more than the original leaf at the equivalent of 50Pa load otherwise not possible without additional test.	Additional test to include the minimum dimension of framing element
A.4.19 Framing elements of leaf or panel	Change of species	≥	>=<	Possible to change species for other solid timber of the same or higher density timber only otherwise not possible without additional test	
A.4.20 Framing elements of leaf or panel	Change of material	>=<	>=<	Not possible	Additional test to include the required material
A.4.21 Jointing technique of internal leaf or panel framing	Alternative	>=<	>=<	Possible for S _a . Possible for S _m providing the stiffness of the leaf is not reduced such that the resulting leaf will not distort more than the original leaf at the equivalent of 50Pa load otherwise not possible without additional test.	The required jointing method & detail shall be tested.
A.4.22 Threshold at the bottom of the door set – See Figure A.8	Add	≥	>=<	Possible for S _a .	
				Possible for S _m providing the tested bottom sealing system is maintained or replaced by the sealing system tested at the upper edges of the door leaf otherwise not possible without additional testing.	The required threshold detail shall be tested.
A.4.23 Threshold at the bottom of the doorset	Remove	=	≤	Possible for S _a	
				Not possible for S _m	The required threshold detail shall be tested.
A.4.24 Decorative leaf or panel edge detail – see Figure A.9	Shape	>=<	>=<	Possible providing the alternative shape doesn't interfere with the sealing system otherwise not possible without additional testing	The required edge detail shall be tested.

Construction Parameter (1)	Variation (2)	Influence of variation on performance characteristic (3)		Possibility of extension (4)	Additional Evidence Required (5)
		S_a	S_m		
A.4.25 Dimension of smoke seals (fitted in leaf or frame)	Increase	>=<	>=<	Possible up to a maximum of 25% in any cross sectional dimension providing the same material and the same manufacturer otherwise not possible without an additional test	Additional test to include maximum size of seals
A.4.26 Dimension of smoke seals (fitted in leaf or frame)	Decrease	>	>	Not possible	Test to include minimum size of seals
A.4.28 Type of smoke seals (fitted in leaf or frame)	Alternative material	>=<	>=<	Not possible	Further test to include the required seal supplier/manufacturer's seal
A.5 Decorative and / or protective finishes					
A.5.1 Decorative laminates on the face of the leaf, panel or frame	Add	=	>=<	Possible for S_a	Additional test to include the required decorative laminate
				Possible for S_m for laminates and veneers up to 1.5mm thick otherwise not possible without an additional test	
A.5.2 Decorative laminates on the face of the leaf, panel or frame	Remove	>=<	>=<	Possible for S_a for laminates and timber veneers up to 1.5mm thick and possible for S_m for timber veneers up to 1.5mm thick otherwise not possible without an additional test	Additional test to include the required decorative laminate/veneer

Construction Parameter (1)	Variation (2)	Influence of variation on performance characteristic (3)		Possibility of extension (4)	Additional Evidence Required (5)
		S _a	S _m		
A.5.5 Types of decorative laminates on the face of the leaf, panel or frame	Change material	=	>=<	Possible for S _a	Additional test to include the required decorative laminate
				Possible for S _m for laminates and veneers up to 1.5mm thick otherwise not possible without an additional test	
A.5.6 Decorative laminates on the edges (on leaf, panel or frame)	Change material/species	≥	≥	Possible providing the sealing system is unaffected otherwise not possible without an additional test	Additional test to include the required change to sealing system
A.5.11 Protective plates – face fixed (kick plates / push plates / protective plates) on leaf or panel	Recessed to unrecessed	>=<	>=<	Possible providing the sealing system is unaffected otherwise not possible without an additional test	Additional test to include the required change to sealing system

Construction Parameter (1)	Variation (2)	Influence of variation on performance characteristic (3)		Possibility of extension (4)	Additional Evidence Required (5)
		S _a	S _m		
A.5.12 Protective metal plates – face fixed (kick plates / push plates / protective plates) on leaf or panel	Unrecessed to recessed	>=<	>=<	Possible for plates up to 1.5mm thick providing the sealing system is unaffected otherwise not possible without an additional test	Additional test to include the required change to sealing system
A.5.13 Protective plates – including kick plates / push plates / protective plates / protective composites and plastic elements, face fixed on leaf or panel – see Figure A.10	Add	≥	>=<	Possible for S _a Possible for S _m providing no thicker than 1.5mm or, if thicker than 1.5mm, limited to one piece up to 800 mm from the base of the leaf or limited to maximum two pieces per face at 250 mm in width or height and providing the sealing system is unaffected otherwise not possible without an additional test.	Additional test to include the required change to sealing system and/or the plate configuration
A.5.14 Protective plates – including kick plates / push plates / protective plates / protective composites and plastic elements, face fixed on leaf or panel	Remove	>=<	>=<	Possible providing the sealing system is unaffected otherwise not possible without an additional test	Additional test to include the required change to sealing system
A.5.15 Protective plates – including kick plates / push plates / protective plates / protective composites and plastic elements, face fixed on leaf or panel	Change material	>=<	>=<	Possible for S _a providing the sealing system is unaffected otherwise not possible without an additional test Also possible for S _m providing the melting point is higher than 200°C and providing the sealing system is unaffected otherwise not possible without an additional test	Additional test to include the required change to sealing system and the alternative material
A.5.16 Attachment technique of protective plates (as described above) on leaf or panel	Alternative (adhesive / screw)	=	=	Possible	
A.5.17 Mouldings (on the face of the leaf or panel)	Add	=	=	Possible	
A.5.18 Mouldings (on the face of the leaf or panel)	Remove	=	=	Possible	

Construction Parameter (1)	Variation (2)	Influence of variation on performance characteristic (3)		Possibility of extension (4)	Additional Evidence Required (5)	
		S_a	S_m			
B. Door Frame						
B.1. General						
B1.1	Position of an access door above floor level	Alternative	=	=	Possible	
B1.2	Position of door frame within the thickness of the supporting construction	Alternative	>=<	>=<	Possible providing the door frame does not project beyond the face of the supporting construction more than tested otherwise not possible without an additional test	Additional evidence to include door frame at required position
B.2 Materials and constructions						
B.2.1	External Dimensions	Increase	>=<	>=<	Possible providing the rebate depth is maintained otherwise not possible without an additional test	Additional test to include door frame with required rebate
B.2.2	External Dimensions	Decrease	>=<	≤	Possible for S_a providing the rebate depth is maintained otherwise not possible without an additional test Not possible for S_m without an additional test	Additional evidence to include door frame at required dimensions

Construction Parameter (1)	Variation (2)	Influence of variation on performance characteristic (3)		Possibility of extension (4)	Additional Evidence Required (5)
		S_a	S_m		
B.2.3 Type of frame material (timber)	Change timber type	\geq	\geq	Possible	
B.2.6 Type of frame material	Interchange material (timber and steel)	$>=<$	$>=<$	Possible for timber doors S_a and S_m to change from steel frame to timber frame or frame made of timber based materials otherwise not possible	Additional test shall provide evidence of each configuration e.g. double leaf, double acting etc, with each type of frame material.
B.2.7 Thickness of steel	Increase	\geq	\geq	Possible	
B.2.8 Thickness of steel	Decrease	\geq	$>=<$	Possible for S_a	
				Not possible for S_m without an additional test	Additional evidence to include door frame at minimum thickness
B.2.9 Type of infill material (in steel frame)	Alternative material	=	$>=<$	Possible for S_a where seal to supporting construction is unchanged otherwise not possible without an additional test	Additional evidence to include door frame with required density material
				Not possible for S_m without an additional test where less dense material is required	
B.2.10 Jointing technique for timber based frame members	Alternative	\leq	\leq	For timber based frames, it is possible to change from nails to screw fixings, or from butt joint to mortice and tenon joint. Also possible to change from staples to nails or screws otherwise additional test is required.	Additional test to include the required jointing method & detail
B.2.11 Assembling technique for metallic frame members	alternative (welding / riveting / screwing / tenoned)	$>=<$	$>=<$	Possible to interchange between techniques	
B.3 Protection					
B.3.1 Protection of frame members – see Figure A.11	Add	$>=<$	$>=<$	Possible providing the protection does not interfere with the smoke seal otherwise without an additional test	Additional test to include the required frame member detail
B.3.2 Protection of frame members	Remove	\geq	\geq	Possible	

Construction Parameter (1)	Variation (2)	Influence of variation on performance characteristic (3)		Possibility of extension (4)	Additional Evidence Required (5)
		S _a	S _m		
C. Building hardware					
C.1 General					
NOTE: It is a requirement of this document that all items of building hardware are in accordance with the relevant technical specification and that the door assembly onto which the building hardware will be fitted is appropriate to that class of use. When considering a change in a parameter of building hardware, the effect on the durability of self-closing shall be considered.					
C.1.1 Latches / locks and strike plates	Alternative	>=<	>=<	Possible providing the hardware does not interfere with the smoke seal more than tested otherwise not possible without additional test	Additional test to include the required hardware item
C.1.2 Strike plates for metallic frames	Add / remove	>=<	>=<	Possible providing the hardware does not interfere with the smoke seal more than tested otherwise not possible without additional test	Additional test to include the required hardware item
C.1.3 Number of latches / locks and strike plates	Increase	>=<	>=<	Possible providing the hardware does not interfere with the smoke seal more than tested otherwise not possible without additional test	Additional test to include the required hardware item
C.1.4 Number of latches / locks and strike plates	Decrease	≤	≤	Not possible for S _a and S _m without an additional full size test unless originally tested with the latch bolt(s) withdrawn	Additional test to include the required number of latches
C.1.5 Position of lock assembly – single element - see Figure A.12	Alternative	>=<	>=<	Possible by 200mm in each direction providing the hardware does not interfere with the smoke seal more than tested	Additional test to include the required positioning
C.1.6 Position of latches / locks and strike plates – multi-point locks	Alternative	≥	>=<	Possible for S _a providing the hardware does not interfere with the smoke seal more than tested otherwise not possible without an additional test. Not possible for S _m without an additional full size test unless originally tested with the latch bolt(s) withdrawn otherwise not possible without additional test.	Additional test to include the required positioning of locks
C.1.7 Strike plates	Alternative	>=<	>=<	Possible providing the hardware does not interfere with the smoke seal more than tested	Additional test to include the required hardware item

Construction Parameter (1)	Variation (2)	Influence of variation on performance characteristic (3)		Possibility of extension (4)	Additional Evidence Required (5)
		S_a	S_m		
C.1.10 Bolts (flush, morticed, internal and surface mounted)	Add	>=<	>=<	Possible providing the hardware does not interfere with the smoke seal more than tested	Test to include the required internal lock assembly
C.1.11 Bolts (flush, morticed, internal and surface mounted)	Remove	\geq	>=<	Possible for S_a .	
				Not possible for S_m without an additional full size test unless originally tested with the latch bolt(s) withdrawn.	Test to include the required internal lock assembly
C.1.12 Bolts (flush, morticed, internal and surface mounted)	Alternative	\geq	>=<	Possible for S_a .	
				Not possible for S_m without an additional full size test unless originally tested with the latch bolt(s) withdrawn.	Test to include the required bolt assembly
C.1.13 Size of leaf cut-out for through items	Increase/decrease	>=<	>=<	Possible to decrease the size but not increase the size otherwise test is required	Test to include the largest size of the hole cut through the leaf
C.1.14 Function of latches / locks (e.g. From normal use to panic use or vice versa)	Alternatives	>=<	>=<	Possible providing the hardware does not interfere with the smoke seal more than tested	Additional test can be single or double leaf doorset.
C.1.15 Door handles, push pads and emergency exit devices to EN 179	Add	>=<	>=<	Possible to add face mounted elements only with any break through being limited to screw fixings and their covering otherwise further test is required	Further test is to include the required elements.
C.1.16 Door handles, push pads and emergency exit devices to EN 179	Remove	>=<	>=<	Possible but the lock assembly has to remain as tested and providing the removal does not expose any areas of potential weakness beneath the element. The removal of the building hardware shall not result in less restraint on the door leaves. Otherwise not possible without an additional test.	Further test is to include the required elements.

Construction Parameter (1)	Variation (2)	Influence of variation on performance characteristic (3)		Possibility of extension (4)	Additional Evidence Required (5)
		S _a	S _m		
C.1.17 Panic devices (to EN 1125)	Add	≥	≥	Possible to add face mounted elements only with any break through being limited to screw fixings and their covering otherwise further test is required	Further test is to include the required elements.
C.1.18 Panic devices (to EN 1125)	Remove	≥	≥	Possible but the lock assembly has to remain as tested and providing the removal does not expose any areas of potential weakness beneath the element. The removal of the building hardware shall not result in less restraint on the door leaves. Otherwise not possible without an additional test.	Further test is to include the required elements.
C.1.19 Dimension of hinges	Increase	>=<	>=<	Possible providing the hardware does not interfere with the smoke seal more than tested. Otherwise not possible without an additional test.	Further test is to include the required elements.
C.1.20 Dimension of hinges	Decrease	≥	≥	Possible	
C.1.21 Hinge fixing type	Alternative	=	=	Possible	
C.1.22 Dimension of dog bolts	Increase	>=<	>=<	Possible providing the hardware does not interfere with the smoke seal more than tested. Otherwise not possible without an additional test.	Further test is to include the required elements
C.1.23 Dimension of dog bolts	Decrease	≥	≥	Possible	
C.1.24 Number of hinges/dog bolts	Increase	>=<	>=<	Possible providing the hardware does not interfere with the smoke seal more than tested. Otherwise not possible without an additional test.	
C.1.25 Number of hinges/dog bolts	Decrease	≥	>=<	Possible for S _a .	
				Not possible for S _m without an additional test	Additional test to include the required number of dog bolts
C.1.26 Hinges / dog bolts of the same type	Change of manufacturer	=	=	Possible providing the hardware does not interfere with the smoke seal more than tested; otherwise not possible without an additional test	Additional test to include the required manufacturer of hinges/ dog bolts
C.1.27 Type of hinges	Alternative material	≥	>=<	Possible for S _a .	

Construction Parameter (1)	Variation (2)	Influence of variation on performance characteristic (3)		Possibility of extension (4)	Additional Evidence Required (5)
		S _a	S _m		
				Possible for S _m without an additional test if hinge unless the components have softening point lower than 200°C otherwise not possible without an additional test	Further test is to include the required hinges.
C.1.28 Type of hinges	Alternative type	>=<	>=<	Possible providing the hinge does not interfere with the sealing system more than tested otherwise not possible without an additional test	Further test is to include the required hinges.
C.1.29 Single axis spring hinges	Change from single axis spring hinge to single axis hinge	>=<	>=<	Possible, provided a previously proven closing device is added and providing the hinge does not interfere with the smoke seal more than tested otherwise not possible without an additional test	Further test is to include the required hinges.
C.1.30 Single axis spring hinges	Change of type from a Single axis hinge to a single axis spring hinge	>=<	>=<	Possible if the spring hinge is successfully tested to EN 1634-1 on a comparable doorset or evaluated against EN 1634-2 and providing the hinge does not interfere with the smoke seal more than tested otherwise not possible without an additional test	Further test is to include the required hinges.
C.1.31 Single axis spring hinges	Addition or exchange of single axis spring hinge of identical design.	>=<	>=<	Possible if the spring hinge is successfully tested to EN 1634-1 on a comparable doorset or evaluated against EN 1634-2 and providing the hinge does not interfere with the smoke seal more than tested otherwise not possible without an additional test	Further test is to include the required hinges.
C.1.32 Distance from top of upper hinge to top of door	Increase	≥	≤	For S _a , possible.	Further test is to include the required positioning of the top hinge.
				Possible for S _m doors subject to a maximum variation of 100 mm.	
C.1.33 Distance from top hinge to top of door	Decrease	≥	≥	Possible	
C.1.34 Distance from bottom of lower hinge to bottom of door	Increase	=	≤	For S _a , possible	Further test is to include the required positioning of the hinge.
				Possible for S _m doors subject to a maximum variation of 100 mm	
C.1.35 Distance from bottom hinge to bottom of door	Decrease	≥	≥	Possible	

Construction Parameter (1)	Variation (2)	Influence of variation on performance characteristic (3)		Possibility of extension (4)	Additional Evidence Required (5)
		S _a	S _m		
C.1.36 Position of intermediate movement restrictors (i.e. hinges or dog bolts) – see Figure A.14	Variation	=	>=<	For S _a , possible	Further test is to include the required positioning of the movement restrictor.
				Possible for S _m doors subject to a maximum variation of 100 mm unless originally tested with the movement restrictor withdrawn.	
C.1.37 Door closer positioning on face of doorset	Alternative side	=	=	Possible	
C.1.38 Concealed door closer positioning in the head/frame of doorset	Change position or product	>=<	>=<	Possible providing the hardware does not interfere with the smoke seal more than tested otherwise not possible without an additional test	Additional test to include the specific closer required
C.1.39 Door closer (leaf or frame mounted)	Exchange concealed for face fixed	>=<	>=<	Possible providing door leaf/frame is 'made good' otherwise not possible without an additional test	Additional test to include the specific detail required
C.1.40 Door closer (leaf or frame mounted)	Exchange face fixed for concealed	≤	≤	Not possible without an additional test	Additional test to include the specific closer required
C.1.41 Door closer of the same type	Change of manufacturer / alternative	>=<	>=<	Possible providing the hardware does not interfere with the smoke seal more than tested otherwise not possible without an additional test	
C.1.42 Floor/transom mounted closing devices/pivots with single action accessories (shoe & top centre)	Exchange from hinges	>=<	>=<	Not possible without an additional test	Additional test to include the specific closer and accessories and doorset configuration
C.1.43 Floor/transom mounted closing devices/pivots with single action accessories (shoe & top centre)	Exchange to hinges	>=<	>=<	Not possible without an additional test	Additional test to include the specific closer and accessories and doorset configuration
C.1.44 Power cable and protective conduits for electric locks (door or frame) – see Figure A.15	Add	>=<	>=<	Possible providing the hardware does not interfere with the smoke seal more than tested otherwise not possible without an additional test	Additional test to include the specific parameter variation

Construction Parameter (1)	Variation (2)	Influence of variation on performance characteristic (3)		Possibility of extension (4)	Additional Evidence Required (5)
		S_a	S_m		
C.1.45 Door viewer	Add	\geq	\geq	Not possible without specific test evidence	Additional test to include the specific parameter variation
C.1.46 Key tubes	Add	\geq	\geq	Not possible without specific test evidence	Additional test to include the specific key tube required
C.1.47 Alarm contacts and proximity switches	Additional/alternative	\geq	\geq	Possible providing the hardware does not interfere with the smoke seal more than tested otherwise not possible without an additional test.	Additional test to include the specific parameter variation
C.1.48 Door signs	Additional	\geq	\geq	Possible	
C.1.49 Threshold seal	Add	\geq	\geq	Possible providing the seal to be added does not interfere with the smoke seal more than tested otherwise not possible without an additional test	Further test to include the door leaf with the required seal
C.1.50 Threshold seal	Remove	\leq	\leq	Possible for S_a doors. Not possible for S_m doors without specific test evidence.	Further test to include the door leaf without a seal
C.1.51 Threshold seal	Alternative type	\leq	\leq	Possible for S_a doors. Not possible for S_m doors without specific test evidence.	Further test to include the required seal

Construction Parameter (1)	Variation (2)	Influence of variation on performance characteristic (3)		Possibility of extension (4)	Additional Evidence Required (5)
		S _a	S _m		
D Side / transom panels and flush over panels					
D.1. Panel arrangements					
D.1.1 Side / transom panel arrangement	Variation of tested arrangement	>=<	>=<	A successful test on a construction indicated by a figure in Annex B would allow the variations indicated in subsequent figures in Annex B and also Figures B.6 and B.7 in double leaf configuration following a B.1 and/or B.2 tested configuration. The above assumes the fixing/retention method of the panelling system is retained otherwise specific test is required.	Specific test needed on required panel arrangement
D.1.2 Flush over panel	Variation of tested arrangement	>=<	>=<	A successful test on a construction indicated by a figure in Annex B would allow the variations indicated in subsequent figures in Annex B and also Figures B.6 and B.7 in double leaf configuration following a B.1 and/or B.2 tested configuration. The above assumes the fixing/retention method of the panelling system is retained otherwise specific test is required.	Specific test needed on required panel arrangement
E Glazing for door leaf or side /over panels					
E.1 General					
E.1.1 Glazed panel	Add	>=<	>=<	Not possible without specific test evidence	Further test to include the door leaf with the required type/size of glazed panel
E.1.3 Thickness of glass	Increase	>=<	>=<	Possible for S _a doors subject to evidence on the sealing system's suitability in an S _a door. Possible for S _m doors subject to evidence on the sealing system's suitability in an S _m door and subject to test evidence on the performance of the glass at 200°C showing that it doesn't break or fracture otherwise not possible without specific test evidence.	Further test to include the door leaf with the required thickness of glazed panel

Construction Parameter	Variation	Influence of variation on performance characteristic		Possibility of extension	Additional Evidence Required
		(1)	(2)		
		S_a	S_m		
E.1.4 Thickness of glass	Decrease	>=<	>=<	Possible for S_a doors subject to evidence on the sealing system's suitability in an S_a door. Possible for S_m doors subject to evidence on the sealing system's suitability in an S_m door and subject to test evidence on the performance of the glass at 200°C showing that it doesn't break or fracture otherwise not possible without specific test evidence.	Further test to include the door leaf with the required thickness of glazed panel
E.1.5 Dimensions of each pane – see Figure A.16	Increase	≤	≤	Not possible	Further test to include the door leaf with the required size of glazed panel
E.1.6 Dimensions of each pane – see Figure A.17	Decrease	=	=	Possible to decrease the size.	Required large of the door leaf without glazed panel shall be tested.
E.1.7 Type of glass	Change of manufacturer and/or glass type	=	>=<	For S_a , possible.	
				Possible for S_m if the glass is fire resistant or will not fracture at temperatures less than 200°C otherwise not possible without an additional test.	Further test to include the door leaf with the required type of glazed panel
E.1.8 Materials and/or geometry of edge fixing technique including seals (with the same glass)	Alternative	≤	≤	Not possible without an additional test	Further test to include the door leaf with the required type of glazed panel
E.1.9 Type/position of glazing bead fixings	Alternative	≤	≤	Not possible without an additional test	Further test to include the door leaf with the required type of glazed panel
E.1.10 Shape of glazing - see Figure A.18	Alternative	>=<	>=<	Possible providing the edge fixing detail is the same and the new shape is within the area of the tested glass otherwise not possible without an additional test	Further test to include the door leaf with the required type of glazed panel

Construction Parameter (1)	Variation (2)	Influence of variation on performance characteristic (3)		Possibility of extension (4)	Additional Evidence Required (5)
		S _a	S _m		
E.1.11 Number of glazed apertures – see Figure A.19	Increase	>=<	>=<	Possible for S _a providing the air leakage rate is calculated proportionately otherwise not possible without an additional test. Not possible S _m without specific test evidence.	Further test to include the door leaf with the required type/size of glazed panel
E.1.12 Number of glazed apertures	Decrease	>	>	Possible up to 50% increase of the tested gap for S _a and S _m doors if the sealing system remains the same otherwise not possible without an additional test	
E.1.13 Distance between the edge of glazing and the perimeter of the door leaf / panel	Increase	=	=	Possible	
E.1.14 Smallest tested distance between the edge of glazing and the perimeter of the door leaf / panel	Decrease	=	≤	Possible for S _a	Further test to include the required minimum dimensions between glazing panel and leaf edge
				For S _m , not possible without an additional test	
E.1.15 Distance between glazed apertures	Increase	=	>	Possible	
E.1.16 Smallest tested distance between glazed apertures - see Figure A.20	Decrease	=	<	Possible for S _a	Further test to include the required minimum dimensions between glazing panels
				Not possible for S _m without an additional test.	
F Supporting construction and attachment (technique) of door frame or side / over panels					
F.1 General					
F.1.1 Supporting construction	Flexible to rigid	=	=	Possible	
F.1.2 Supporting construction	Rigid to flexible	=	=	Possible	
F.1.3 Type of fixings	Alternative type and/or manufacturer	=	=	Possible	
F.1.4 Number and size of fixings	increase	=	=	Possible	
F.1.5 Number and size of fixings	Decrease	=	=	Possible	
F.1.6 Distance between fixings	Increase	=	=	Possible	

Construction Parameter (1)	Variation (2)	Influence of variation on performance characteristic (3)		Possibility of extension (4)	Additional Evidence Required (5)
		S _a	S _m		
F.1.7 Distance between fixings	Decrease	=	=	Possible	
F.1.8 Fixing to floor	Cleated to sunk	=	=	Possible	
F.1.9 Fixing to floor	Sunk to cleated	=	=	Possible	
F.1.10 Gap between door leaf and floor	Increase	=	>=<	Possible for S _a	
				Not possible without specific test	Test to include maximum required threshold gap
F.1.11 Gap between door leaf and floor	Decrease	=	>=<	Possible for S _a	
				Possible for S _m if tested sealing system can be maintained otherwise not possible without specific test	Test to include required threshold gap and sealing system
F.1.12 Gap between door frame and wall	Increase	>=<	>=<	Not possible without specific test	Test to include maximum required frame to wall gap
F.1.13 Gap between door frame and wall	Decrease	>=<	>=<	Possible providing sealing method remains as tested otherwise not possible without an additional test	Test to include maximum required frame to wall gap sealing method
F.1.14 Sealing of the gap between door frame and wall	Alternative seal	>=<	>=<	Alternative type is possible providing the sealing system has been successfully tested in the same condition. The seal can not be removed otherwise not possible without an additional test.	Test to include maximum required frame to wall gap sealing method

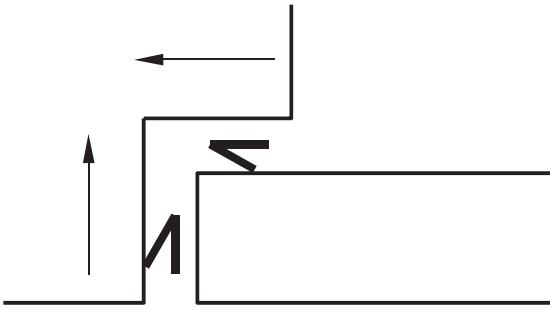

Figure A.1 – Smoke seals (fitted at leaf to frame interface)

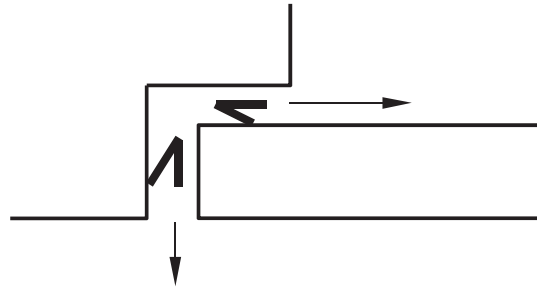

Figure A.2 – Smoke seals (fitted at leaf to frame interface)

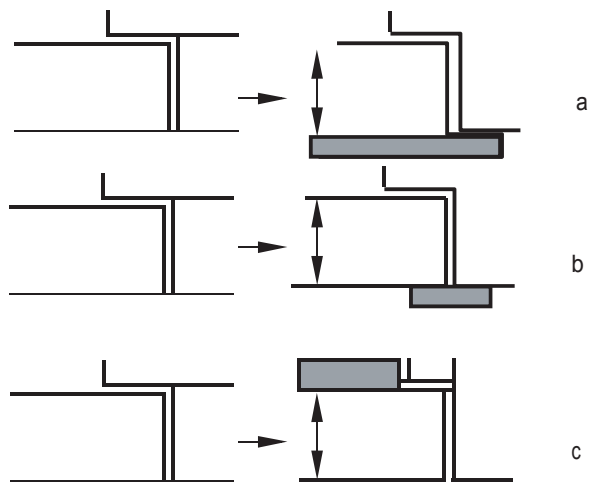
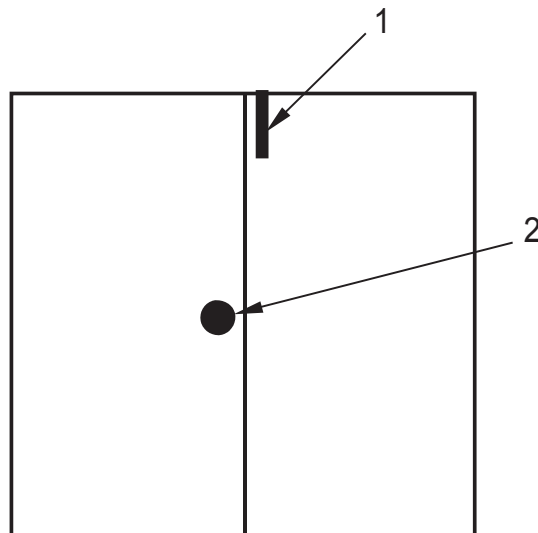

Figure A.4 – Leaf edge rebate (to door leaf or panel – not at the meeting edges)



Key

- 1 = Bolt
- 2 = Latch

Figure A.5 – Latched condition for double leaf doorsets

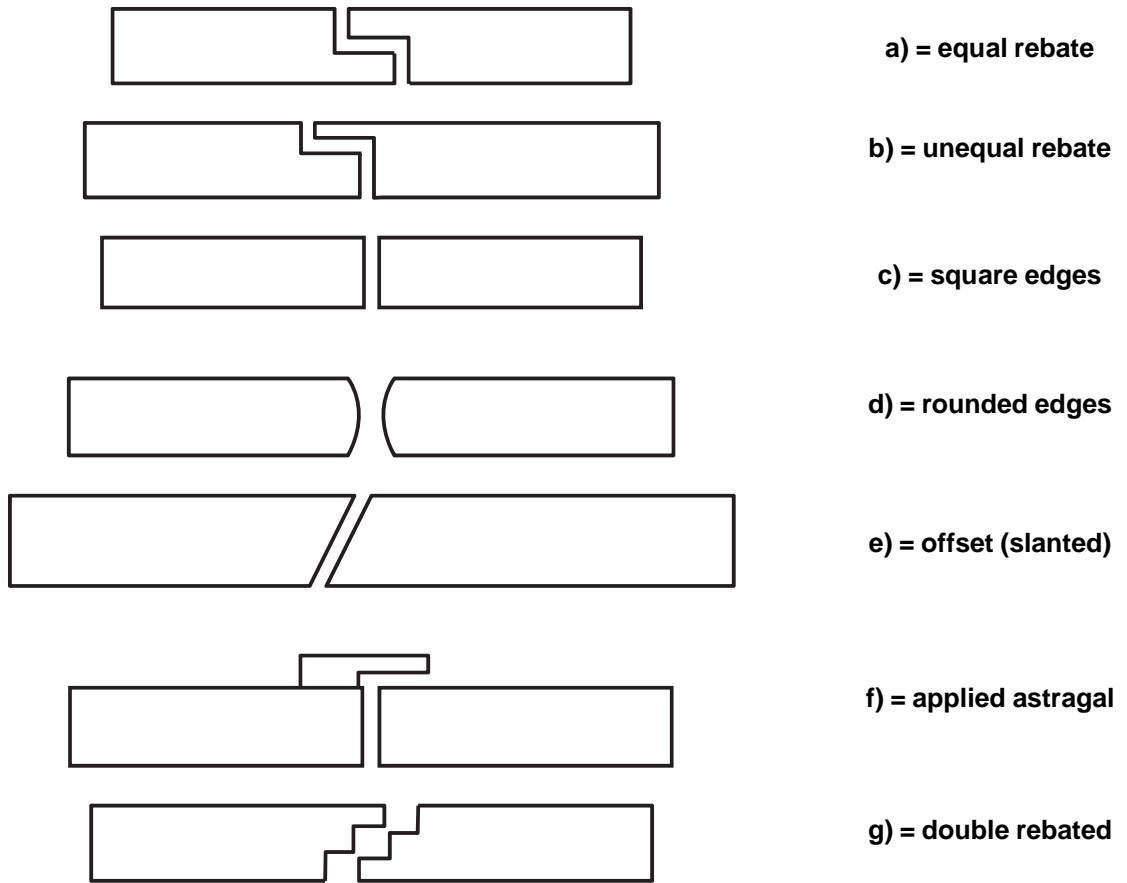

Figure A.6 – Meeting edge details

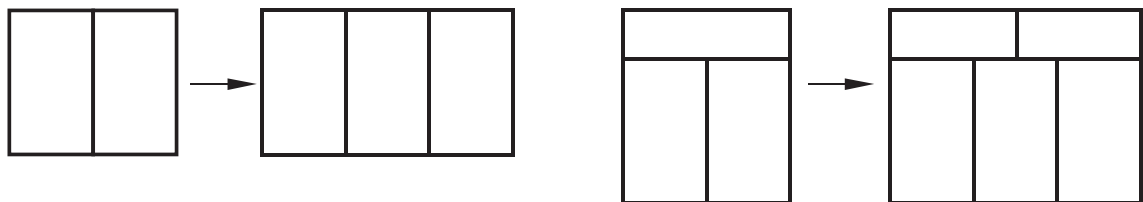

Figure A.7 – Pattern of core material of leaf or panel (2 examples shown)

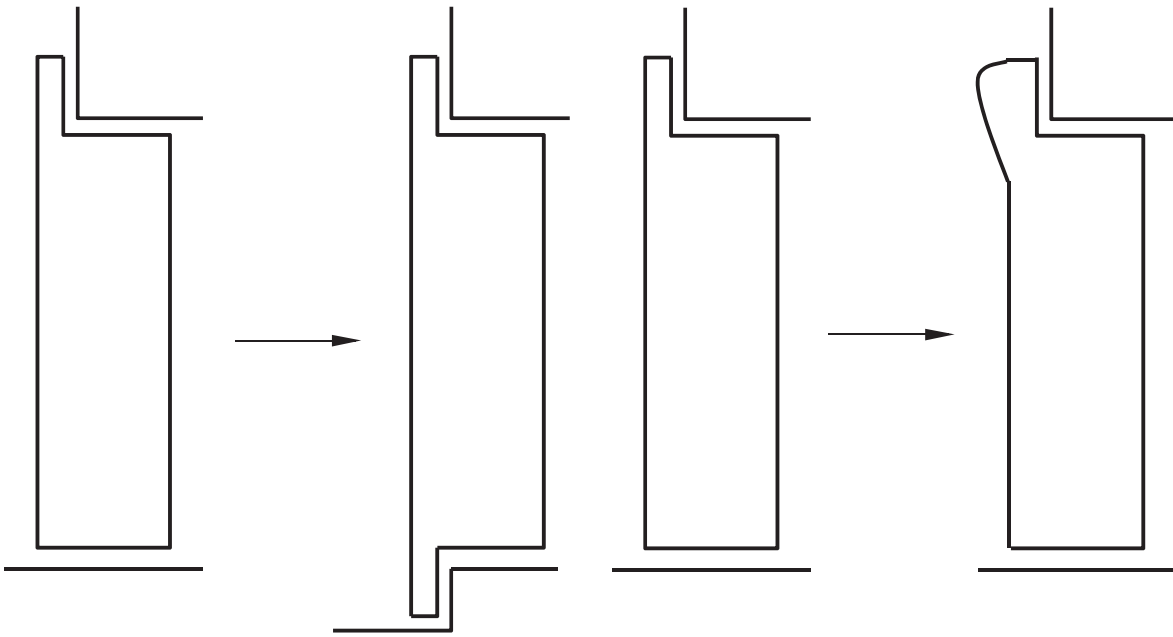

Figure A.8 – Timber threshold at the bottom of the door leaf or panel

Figure A.9 – Decorative leaf or panel edge details (example only)

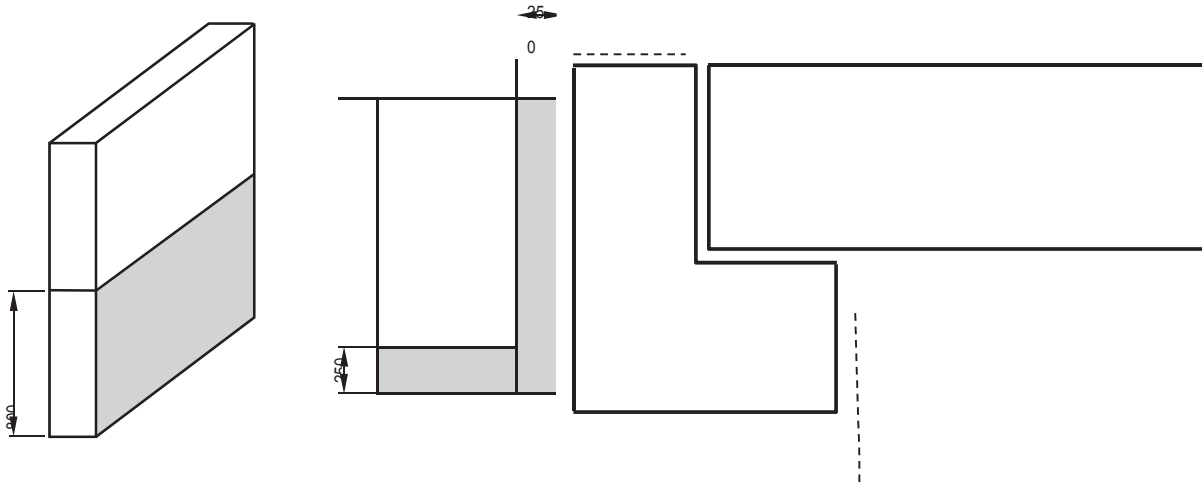

Figure A.10 – Protective plates

Figure A.11 – Protection of frame members

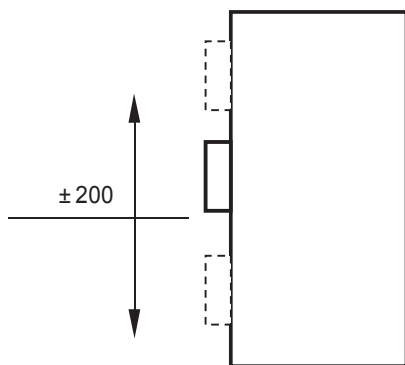

Figure A.12 – Position of lock assembly

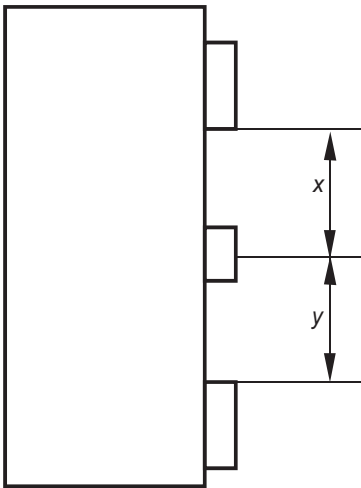

Figure A.14 – Position of intermediate movement restrictors (i.e. hinges or dog bolts)

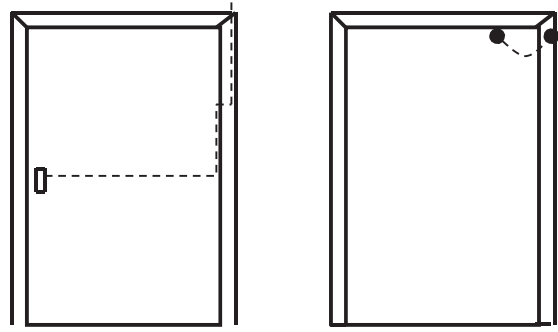

Figure A.15 – Power cable and protective conduits for electric locks (door or frame)

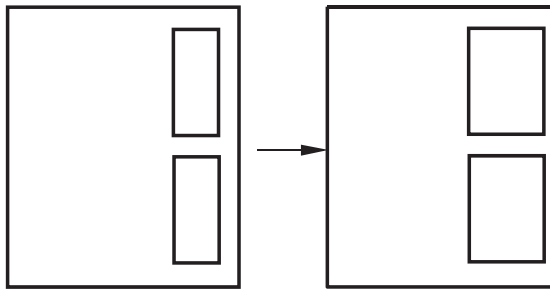

Figure A.16 – Dimensions of each pane

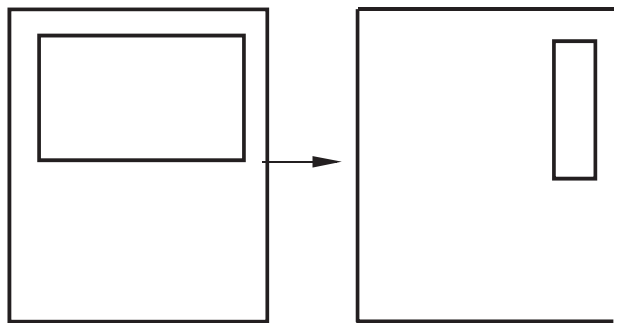
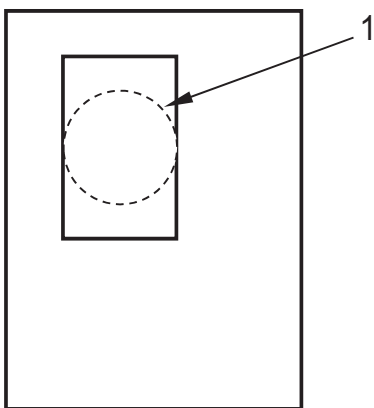

Figure A.17 – Dimensions of each pane



KEY
1 = eg

Figure A.18 – Shape of glazing

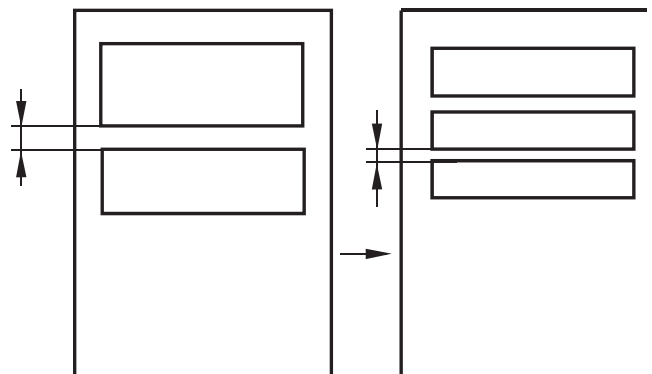

Figure A.19 – Number of glazed apertures

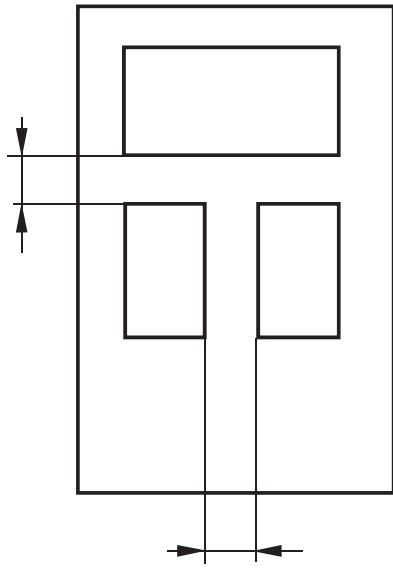

Figure A.20 – Distance between glazed apertures

Table B

Arrangements for doorsets incorporating side and/or overpanels

A successful test on the configuration shown below in Figure B.1 will cover the variations shown in Figures B.2 to B.7 by reference to Annex A, Section D.

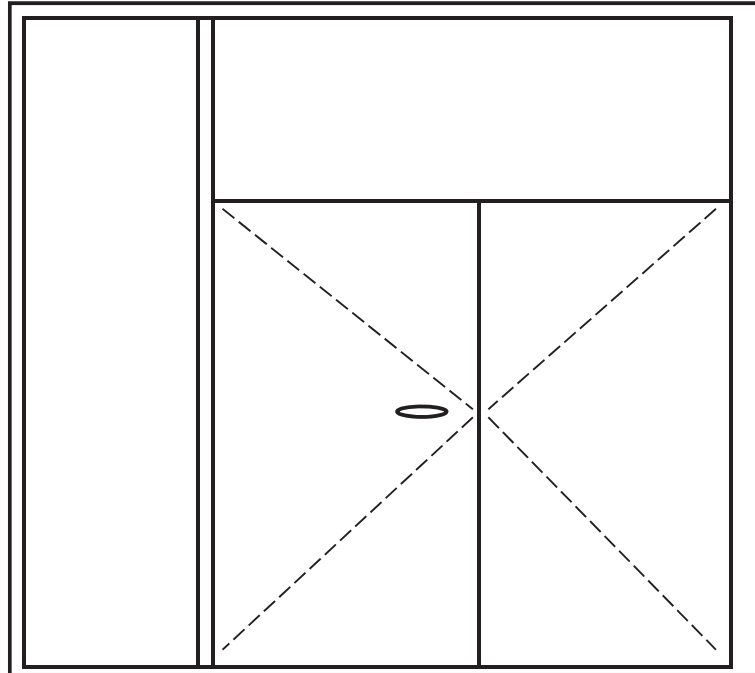

Figure B.1 – Arrangement to test for double leaf configurations without a transom member

A successful test on the configuration shown below in Figure B.2 will cover the variations shown in Figures B.3 to B.7 by reference to Annex A, Section D.

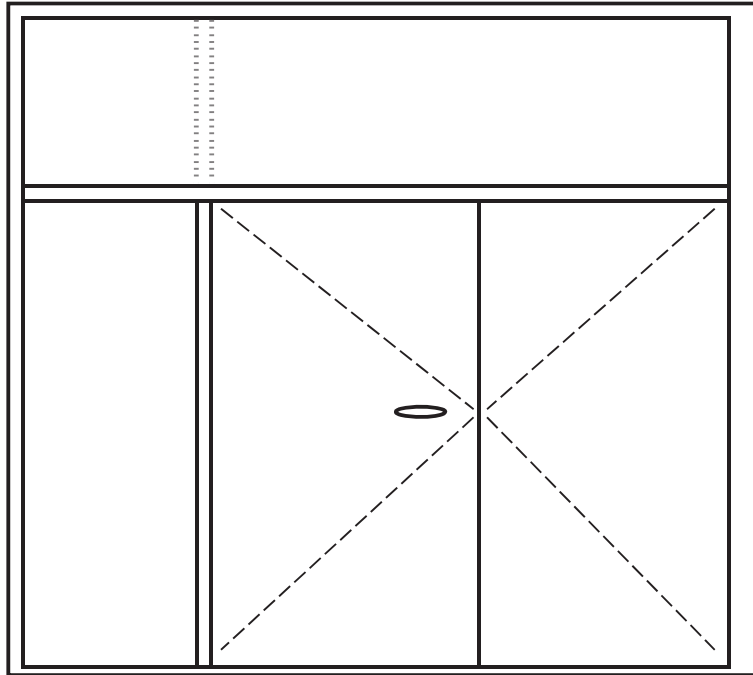

Figure B.2 – Arrangement to test for double leaf configurations with a transom member

A successful test on the configuration shown below in Figure B.3 will cover the variations shown in Figures B.4 to B.7 by reference to Annex A, Section D.

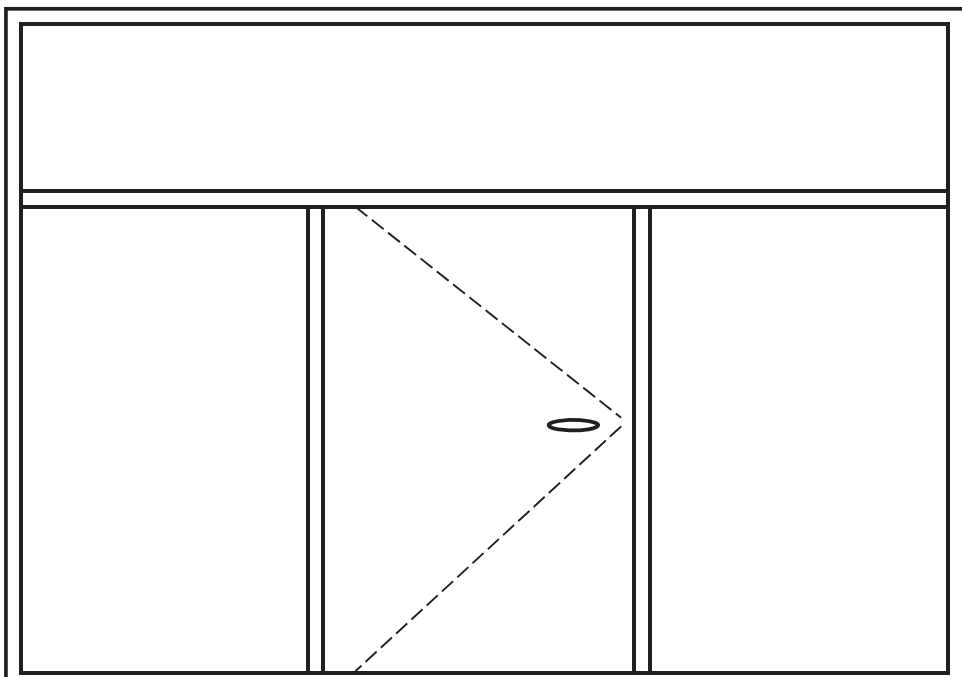

Figure B.3

A successful test on the configuration shown below in Figure B.4 or B.5 will cover the variations shown in Figures B.6 and B.7 by reference to Annex A, Section D.

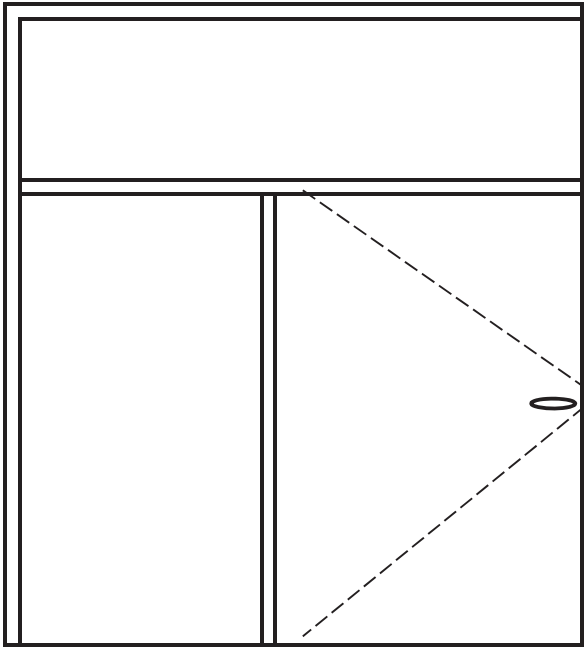

Figure B.4

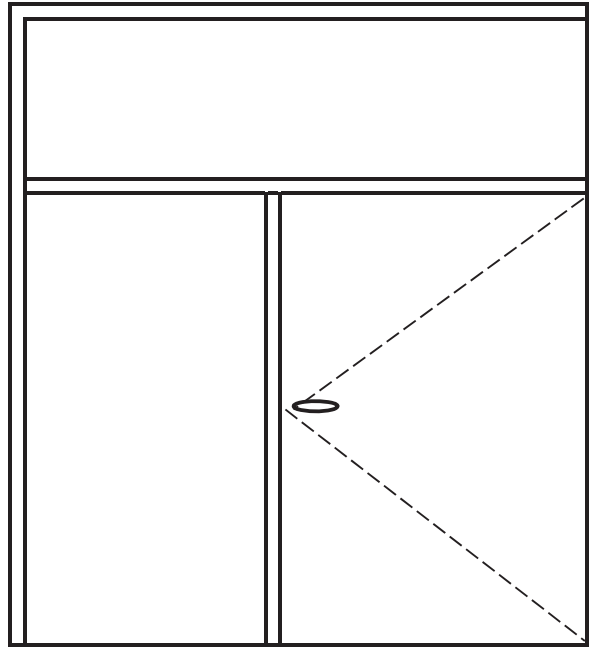

Figure B.5

A successful test on the configuration shown below in Figure B.6 will cover the variation shown in Figure B.7 by reference to Annex A, Section D.

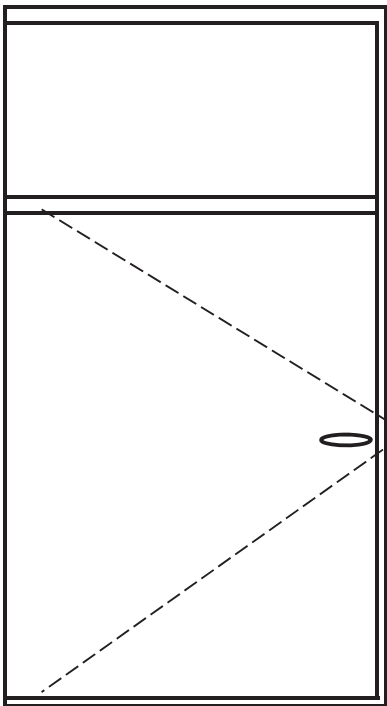

Figure B.6

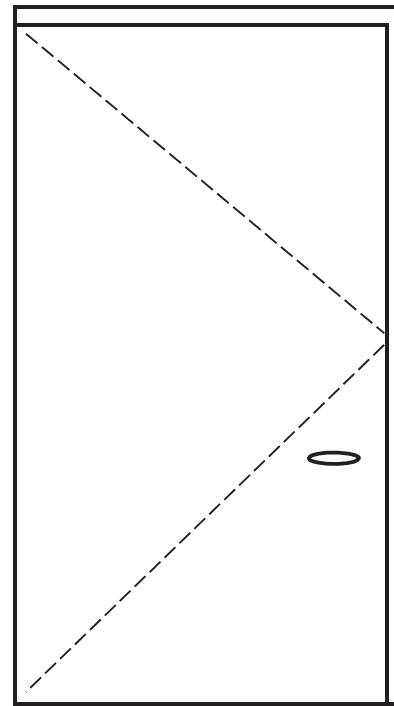

Figure B.7

Annex C – Extended application permanent function

1. General

Annex C covers single and double leaf, hinged and pivoted, steel based doorsets covered by EN 15269-2 and prescribes the methodology for extending the application of test results obtained from durability self-closing test(s) conducted in accordance with EN 1191.

Before there can be any consideration for extended application, the doorset will need to have been tested in accordance with EN 1634-1 resp. EN 1634-3 and EN 1191 to achieve a test result which could generate a classification in accordance with EN 13501-2 at least equal to the classification subsequently required from extended application considerations.

Subject to the completion of the appropriate self-closing test or tests, the extended application may cover all or some of the following examples:

- door leaf;
- side, transom and/or overpanels;
- wall/ceiling fixed elements (frame/suspension system);
- glazing for door leaf, side, transom and flush over panels;
- items of building hardware;
- decorative finishes;
- intumescent, smoke, draught or acoustic seals;
- alternative supporting construction(s).

2. Determination of the field of extended application

Before there can be any consideration for extended application the doorset shall have been tested and classified in accordance with EN 1191 and EN 13501-2 in order to establish a classification for the doorset. Before the extended application process can be applied on a construction parameter variation it shall be ensured that the varied doorset is able to self-close without restraint at least once.

A review of the doorset construction parameters can indicate that one or more characteristics may be improved by a particular parameter variation. All evaluations shall be made on the basis of retaining the classifications obtainable from testing to EN 1191, including those with a lower number of opening and closing cycles. However, this shall never lead to an increased classification for any specific parameter beyond that achieved during any one test unless specifically identified in the relevant Construction Parameter Variation tables.

All evaluations shall be made on the basis of retaining the classification obtained from testing to EN 1634-1 or EN 1634-3.

If, when following the extended application procedure, any Part of the classified product cannot be covered by the extended application rules, that Part shall be omitted from the subsequent extended application report and classification report.

Identify the variations from the original test specimen(s) which are required to be covered by an extended application report.

Locate the variations in the appropriate parameter variation by reference to columns (1) and (2) of table A.

Establish from the contents of column (4) of table A whether any extended application is available without the need for further testing.

Where this is deemed to be possible this can be recorded in the extended application report together with any appropriate restrictions and the stated rules from column (4) in table A.

Where the variations required can only be achieved from additional testing according to column (5), the additional test can be made on a similar specimen type to the original test against which the extended application is sought. Alternatively, column (5) in table A identifies an option for alternative testing and relevant test parameters.

3 Procedure for maximum field of extended application

It is possible to provide a limited field of extended application from the results of a single test. However, where a manufacturer intends to produce a range of doors incorporating single doors and also double doors with or without glazing, with alternative elements of building hardware, etc., it is recommended that careful consideration is given to the complete range of doorset designs and options in order to minimize the testing required before testing commences.

Establish all the parameter variations which are required to be Part of the product range.

Determine which are the most important specification requirements and incorporate as many as possible into the specimen(s) for the first tests in the series.

Conduct the first durability test or a series of tests and then establish which of the original desired parameter variations have not been covered by this test(s).

Identify these parameter variations in table A and establish if any extended application is possible without further testing.

Record this for the extended application report together with any restrictions and rules given in column (4) in table A.

Evaluate which, if any, of the desired parameter variations have not been covered by the initial field of extended application derived from chapter 3.

Determine if the product range is to include only single leaf doorsets or if the range is to also include double leaf configurations. Where only single doorsets are to be Part of the product range, the outstanding construction parameter variations shall only be incorporated into specimens for the single leaf doorsets. Where single leaf and double leaf doorsets are to be included in the product range, the outstanding construction parameter variations for the extended application of single leaf doorsets may be incorporated into either repeated single leaf doorset tests or, in the weakest option, as defined in column (5) of the table in table A, double leaf doorset configurations.

Select the required outstanding parameter variations from column (1) and column (2) of table A and observe from column (5) in table A which are the most appropriate weakest specimen options for further testing.

If the complete selection of required parameter variations has not been covered by the tests listed above, then an appropriate test or tests may be carried out with the additional product variations incorporated.

4 Interpretation of test results

In order to maximize the extended field of application, it is important that the test reports shall record details of any premature integrity and/or insulation failure also record details of any distortion to evaluate low, medium and high distortion (see table A).

Where a series of tests have been conducted, the field of extended application shall be based on the lowest performance achieved from the complete series of tests unless premature failure has been attributed to one or more specific construction parameter variations.

Where it has been possible to identify specific parameter failures, the extended application for all other construction parameter variations can be based on the performance achieved after isolating the premature failure(s).

5 Construction parameter variations

Table A below is designed to be used by experts competent in the field of fire resistance and self-closing durability testing of hinged and pivoted steel doorsets.

The table shall only be used to assess a field of extended application when at least one positive self-closing durability test to EN 1191 has generated a classification according to EN 13501-2.

The first two columns identify possible variations to the construction details of the specimen tested. It is presupposed that the variation does not restrain the door closing.

Column (4) leads to the judgement of the possibility of extending the field of application.

Where additional tests are deemed to be necessary, the type of specimen approved for incorporation of the changed parameter is defined in column (5). Where it is possible to use information from tests performed on one configuration for evidence on a different configuration, this allowance has been made in order to reduce the overall number of tests required for extended application evaluation e.g. single action doorsets to double action doorsets.

Where an additional test is required in column (5), the test is a full scale test unless otherwise specified. In order to maximize the possible field of application from a minimum number of tests, the parameter changes have been spread over a series of test specimens. The recommended tests for each parameter is depending upon the classification required and the preferred direction of testing as indicated in column (5).

Where more than a single parameter variation is required, the influence on other variations shall also be taken into account.

Table A - Construction parameter variations

Construction Parameter	Variation	Influence of variation on performance characteristic	Possibility of extension	Additional Evidence Required
(1)	(2)	(3)	(4)	(5)
A Door leaf				
In certain cases, the rules given in Section A are also appropriate to side, transom and flush over panels or the door frame; where this is the case it is clearly indicated at the beginning of the relevant section. For double leaf door sets, both leaves shall be of the same basic construction.				
A.1 General				
A.1.1 Number of leaves only applicable to doorsets tested without transom and/or flush over panels - see Annex B	Single leaf from double leaf test	=	Possible	-
A.1.2 Number of leaves only applicable to doorsets tested without transom and/or flush over panels - see Annex B	Double leaf from single leaf test	<	Not possible without an additional test	Additional test double leaf doorset
A.1.3 Number of panels per leaf (primary or secondary)	Add (one panel per leaf – on any leaf)	=	Possible if tested at least one leaf (single, primary or secondary) with the minimum of two panels, panel size not increased and the intended jointing technique centrally located in the door leaf Otherwise not possible without an additional test	Additional test double for single and double leaf door sets or single for single leaf doorsets
A.1.4 Number of panels per leaf (primary or secondary)	Reduce (one panel per leaf)	=	Possible providing the tested width of the panel is not increased Otherwise not possible without an additional test	Additional test double for single and double leaf door sets or single for single leaf doorsets
A.1.5 Intumescent seals between frame and door leaf/leaves	Location towards the frame rebate	>=<	Possible	-
A.1.6 Intumescent seals between frame and door leaf/leaves	Location away from the frame rebate	>=<	Possible	-
A.1.7 Intumescent seals between meeting edges of the door leaves	Location	>=<	Possible	-
A.1.8 Non intumescent seals between frame and door leaf/leaves (draught/smoke/acoustic etc.) - Euroclass A1, e.g. ceramic products (fitted in leaf or frame)	Location	=	Possible	-

Construction Parameter	Variation	Influence of variation on performance characteristic	Possibility of extension				Additional Evidence Required
(1)	(2)	(3)	(4)				(5)
A.1.9 Non intumescent seals between meeting edges of the door leaves (draught/smoke/acoustic etc.) - Euroclass A1, e.g. ceramic products	Location	>/=/<	Possible				-
A.1.10 Non intumescent seals/combination of non-intumescent and intumescent seals between door leaves and/or frames (draught /smoke/acoustic etc.) - Euroclass A1 (fitted in leaf or frame).	Location	>/=/<	Possible providing the deformation of the seal will not increase during movement of the door leaf/leaves Otherwise not possible without an additional test				Additional test double for single and double leaf door sets or single for single leaf doorsets
A.1.11 Non intumescent seals between door leaves and/or frames (draught/smoke/acoustic etc.) - Euroclass A1, e.g. ceramic products (fitted in leaf or frame)	Add	>/=/<	Not possible without an additional test				Additional test double for single and double leaf door sets or single for single leaf doorsets
A.1.13 Non intumescent seals between door leaves and/or frames (draught/smoke/acoustic etc.) – < Euroclass A1 (fitted in leaf or frame)	Add	=	Not possible without an additional test				Additional test double for single and double leaf door sets or single for single leaf doorsets
A.1.20 Rebate (door leaves to frames)	Add	=	Possible				-
A.1.21 Rebate (meeting edges)	Add (one rebate)	=	Possible				-
A.1.22 Rebate (door leaves to frames)	Remove	=	Possible				-
A.1.23 Rebate (meeting edges)	Remove	=	Possible				-
A.1.24 Latched condition for single and double leaf doorsets	Change in latching condition	=	Possible in line with the following relationship:				Additional test double for single and double leaf doorsets or single for single leaf doorsets
				Tested without a latch/lock	Tested with a latch/lock but unlatched	Tested with a latch/lock latched	
			Extension to: without a lock/latch	-	Possible	Not possible	
			Extension to: with lock/latch but unlocked/ unlatched	Possible	-	Not possible	
	Extension to: with a lock/latch, latched	Not possible	Not possible	-			
A.2 Size variations/single or multiple panel construction							
A.2.1 Size (area, width, height)	Decrease	>	Possible				

Construction Parameter	Variation	Influence of variation on performance characteristic	Possibility of extension	Additional Evidence Required
(1)	(2)	(3)	(4)	(5)
A.2.2 Height	Increase	=	Possible providing the requirements of Annex B are fulfilled Otherwise not possible without an additional test	Additional test double for single and double leaf doorsets or single for single leaf doorsets
A.2.3 Width	Increase	>/=/<	Possible by a maximum of 25 % providing that the requirements of Annex B are fulfilled Otherwise not possible without an additional test	Additional test double for single and double leaf doorsets or single for single leaf doorsets
A.2.4 Area -	Increase	>/=/<	Possible in line with A.2.2 and A.2.3 Otherwise not possible without an additional test	Additional test double for single and double leaf doorsets or single for single leaf doorsets
A.2.5 Thickness of the door leaf	Increase	>/=/<	Possible providing the requirements of Annex B are fulfilled and by a maximum of 25 % Otherwise not possible without an additional test	Additional test double for single and double leaf doorsets or single for single leaf doorsets
A.3. Materials and constructions				
A.3.17 Metal armour sheet (internally mounted)	Add	=	Possible providing the requirements of Annex B are fulfilled Otherwise not possible without an additional test	Additional test single or double leaf doorset
A.3.19 Electronic security mesh	Add	=	Possible	-
A.3.20 Electronic security mesh	Remove	=	Possible	-
A.3.21 Thickness of steel sheet	Increase	>/=/<	Possible up to a maximum of 10 % above 10 % possible providing the requirements of Annex B are fulfilled Otherwise not possible without an additional test	Additional test single or double leaf doorset
A.3.22 Thickness of steel sheet	Decrease	>/=/<	Possible up to a maximum of 25 % Otherwise not possible without an additional test	Additional test double for single and double leaf doorsets or single for single leaf doorsets
A.3.23 Type of steel sheet	Mild to stainless	-	Possible	-
A.3.24 Type of steel sheet	Stainless to mild	=	Possible	-
A.3.25 Cross-section dimension of stiffening elements	Increase	=	Possible providing the requirements of Annex B are fulfilled Otherwise not possible without an additional test	Additional test double for single and double leaf doorsets or single for single leaf doorsets

Construction Parameter	Variation	Influence of variation on performance characteristic	Possibility of extension	Additional Evidence Required
(1)	(2)	(3)	(4)	(5)
A.3.27 Number of intermediate stiffening elements	Increase	=	Possible providing the requirements of Annex B are fulfilled Otherwise not possible without an additional test	Additional test double for single and double leaf doorsets or single for single leaf doorsets
A.3.29 Stiffening elements	Location	=	Possible	-
A.3.32 Overlap dimension of leaf edge rebate (between leaf and frame)	Increase	=	Possible	-
A.3.33 Overlap dimension of panel edge rebate (meeting edges)	Increase	=	Possible	-
A.3.34 Overlap dimension of leaf edge rebate (between leaf and frame)	Decrease	=	Possible	-
A.3.35 Overlap dimension of panel edge rebate (meeting edges)	Decrease	=	Possible	-
A.3.37 Additional overlapping edge at the bottom of the door leaf	Remove	=	Possible	-
A.3.38 Leaf edge detail (between leaf and frame and meeting edges)	Shape	=	Possible	-
A.3.39 Jointing/assembly technique (leaf edges, stiffening elements etc.) for leaf or frame	Alternative (welding/ riveting/screwing)	>/=/<	Possible to interchange only between riveting and screwing, providing that the centre distances are not exceeded and the cross section dimension of the alternative (rivets/screws) is not smaller Otherwise not possible without an additional test	Additional test double for single and double leaf doorsets or single for single leaf doorsets
A.3.40 Dimension of intumescent seals (leaf or frame fitted)	Increase	=	Possible	-
A.3.41 Dimension of intumescent seals (leaf or frame fitted)	Decrease	=	Possible	-
A.3.42 Type of intumescent seals (leaf or frame fitted)	Change of supplier/ manufacturer	=	Possible	-
A.3.43 Type of intumescent seals (leaf or frame fitted)	Alternative material	=	Possible	-
A.3.44 Dimension of draught/smoke seals (Euroclass A1); e.g. ceramic products (leaf or frame fitted)	Increase	>/=/<	Possible up to a maximum of 15 % in any cross sectional dimension and up to a maximum of 10 % mass Otherwise not possible without an additional test	Additional test double for single and double leaf doorsets or single for single leaf doorsets

Construction Parameter	Variation	Influence of variation on performance characteristic	Possibility of extension	Additional Evidence Required
(1)	(2)	(3)	(4)	(5)
A.3.46 Dimension of draught/smoke seals (< Euroclass A1) - leaf or frame fitted	Increase	>/=/ <	Possible up to a maximum of 15 % in any cross sectional dimension and up to a maximum of 10 % mass Otherwise not possible without an additional test	Additional test double for single and double leaf doorsets or single for single leaf doorsets
A.4. Decorative and/or protective finishes				
A.4.1 Paints without contribution to fire resistance (on leaf or frame)	Addition	=	Possible	-
A.4.2 Paints without contribution to fire resistance (on leaf or frame)	Interchange	=	Possible	-
A.4.3 Thickness of paints with positive contribution to fire resistance (on leaf or frame)	Increase	=	Possible	-
A.4.4 Thickness of paints with positive contribution to fire resistance (on leaf or frame)	Decrease	=	Possible	-
A.4.5 Type of paints with positive contribution to fire resistance (on leaf or frame)	Change of supplier/ manufacturer	=	Possible	-
A.4.6 Type of paints with positive contribution to fire resistance (on leaf or frame)	Alternative material	=	Possible	-
A.4.7 Decorative laminates on the face (on leaf or frame)	Add	=	Possible in line with direct application according to EN 1634-1 Otherwise not possible without additional test	Additional test double for single and double leaf doorsets or single for single leaf doorsets
A.4.8 Decorative laminates on the face (on leaf or frame)	Remove	=	Possible	-
A.4.9 Decorative laminates on the edges (on leaf or frame)	Add	=	Possible providing primary gaps remain within the tolerances given in EN 1634-1- Otherwise not possible without additional test	Additional test single or double leaf doorset
A.4.10 Decorative laminates on meeting edges	Add	=	Possible providing primary gaps remain within the tolerances given in EN 1634-1- Otherwise not possible without additional test	Additional test double leaf doorset
A.4.11 Decorative laminates on the edges (on leaf or frame)	Remove	=	Possible	-

Construction Parameter	Variation	Influence of variation on performance characteristic	Possibility of extension	Additional Evidence Required
(1)	(2)	(3)	(4)	(5)
A.4.12 Types and thickness of decorative laminates on the face (on leaf or frame)	Change material content, increase, decrease	=	Possible	-
A.4.13 Types and thickness of decorative laminates on the edges (leaf to frame)	Change material content, increase, decrease	=	Change of material possible Decrease possible Increase possible providing primary gaps remain within the tolerances given in EN 1634-1 Otherwise not possible without additional test	Additional test single or double leaf doorset
A.4.14 Types and thickness of decorative laminates on the meeting edges	Change material content, increase, decrease	=	Change of material possible Decrease possible Increase possible providing primary gaps remain within the tolerances given in EN 1634-1 Otherwise not possible without additional test	Additional test double leaf doorset
A.4.15 Types of decorative laminates on the face/edges (on leaf or frame)	Colour, pattern	=	Possible	-
A.4.16 Protective elements – face fixed (kick plates/push plates/armour plates)	Add	=	Possible providing no thicker than 1,5 mm and providing the requirements of Annex B are fulfilled Otherwise not possible without an additional test	Additional test single or double leaf doorset
A.4.17 Protective elements – face fixed (kick plates/push plates/armour plates)	Remove	=	Possible	-
A.4.18 Attachment technique for elements added to doors	Selection (adhesive/rivet/screw)	=	Possible	-
A.4.19 Mouldings/profiles	Add	=	Possible providing the requirements of Annex B are fulfilled Otherwise not possible without an additional test	Additional test single or double leaf doorset
A.4.20 Mouldings/profiles	Remove	=	Possible	-
B. Door Frame				
B.1. General				
For intumescent/draught/smoke seals refer to sections A.1				
B.1.1 Threshold/sill/frame member to bottom of door frame	Add	=	Possible	-

Construction Parameter	Variation	Influence of variation on performance characteristic	Possibility of extension	Additional Evidence Required
(1)	(2)	(3)	(4)	(5)
B.1.2 Threshold/sill/frame member to bottom of door frame	Remove	=	Possible	-
B.1.3 Height of hatch door frame above floor	Variation	=	Possible	-
B.2. Materials and constructions				
B.2.1 Overall dimensions and shape	Increase	>/=/<	Possible providing the cross section detail at the overlap/rebate position is retained and/or possible to increase the overlap/rebate detail in line with the increase of the thickness of the door leaf Otherwise not possible without an additional test	Additional test double for single and double leaf doorsets or single for single leaf doorsets
B.2.2 Overall dimensions and shape	Decrease	>/=/<	Possible providing the cross section detail at the overlap/rebate position is retained and/or possible to decrease the overlap/rebate detail in line with the decrease of the thickness of the door leaf Otherwise not possible without an additional test	Additional test double for single and double leaf doorsets or single for single leaf doorsets
B.2.3 Type of infill material	Change of supplier/ manufacturer of material with identical composition and properties	=	Possible	-
B.2.4 Type of infill material	Alternative material	=	Possible providing tested without any infill material Otherwise not possible without an additional test	Additional test double for single and double leaf doorsets or single for single leaf doorsets
B.2.5 Thickness of metal	Increase	=	Possible	-
B.2.6 Thickness of metal	Decrease	=	Possible up to a maximum of 25 % Otherwise not possible without additional test	Additional test double for single and double leaf doorsets or single for single leaf doorsets
B.2.7 Type of metal	Mild to stainless	=	Possible	-
B.2.8 Type of metal	Stainless to stainless	=	Possible	-

Construction Parameter	Variation	Influence of variation on performance characteristic	Possibility of extension	Additional Evidence Required
(1)	(2)	(3)	(4)	(5)
C. Hardware				
EN 16035 may provide information for the interchangeability of hardware.				
C.1. General				
C.1.1 Latches/locks and strike plates	Alternative	=	<p>Possible providing the alternative hardware is of the same type (internally mounted/mortised or surface mounted) and complies with its relevant product standard. The classification for category of use, durability of latch action, door mass and closing force according to EN 12209, prEN 15685 or EN 14846 shall be in line with the intended durability of self-closing classification of the doorset and comply with the mass of the door</p> <p>The type of fixings shall not be changed and the number of fixings shall not be reduced</p> <p>Otherwise not possible without an additional test</p>	Additional test double for single and double leaf doorsets or single for single leaf doorsets
C.1.2 Number of latches/locks and strike plates	Increase		Possible	-
C.1.3 Number of latches/locks and strike plates	Decrease	=	<p>Possible providing one latch/lock is retained</p> <p>Otherwise not possible without an additional test</p>	Additional test double for single and double leaf doorsets or single for single leaf doorsets
C.1.4 Locking system	Exchange single latch/lock to multipoint locking system	=	<p>Possible providing the alternative hardware is of the same type (internally mounted/mortised or surface mounted) and complies with its relevant product standard. The classification for category of use, durability of latch action, door mass and closing force according to EN 12209, prEN 15685 or EN 14846 shall be in line with the intended durability of self-closing classification of the doorset and comply with the mass of the door.</p> <p>The type of fixings shall not be changed and the number of fixings shall not be reduced</p> <p>Otherwise not possible without an additional test</p>	Additional test double for single and double leaf doorsets or single for single leaf doorsets
C.1.5 Locking system	Exchange multipoint locking system to single latch/lock	=	Possible	-

Construction Parameter	Variation	Influence of variation on performance characteristic	Possibility of extension	Additional Evidence Required
(1)	(2)	(3)	(4)	(5)
C.1.6 Position of single latch/lock/strike plate	Alternative	=	Possible 300 mm variation Otherwise not possible without an additional test	Additional test double for single and double leaf doorsets or single for single leaf doorsets
C.1.7 Position of multiple latches/locks/strike plates (with or without connecting rods)	Alternative	=	Possible	-
C.1.8 Latches/locks and strike plates of the same type	Change of supplier/ manufacturer	=	Possible providing the alternative hardware is of the same type (internally mounted/mortised or surface mounted) and complies with its relevant product standard. The classification for category of use, durability of latch action, door mass and closing force according to EN 12209, prEN 15685 or EN 14846 shall be in line with the intended durability of self-closing classification of the doorset and comply with the mass of the door. The type of fixings shall not be changed and the number of fixings shall not be reduced Otherwise not possible without an additional test	Additional test double for single and double leaf doorsets or single for single leaf doorsets
C.1.9 Latches/locks and strike plates of the same type	Alternative material	=	Possible providing the alternative hardware is of the same type (internally mounted/mortised or surface mounted) and complies with its relevant product standard. The classification for category of use, durability of latch action, door mass and closing force according to EN 12209, EN 15685 or EN 14846 shall be in line with the intended durability of self-closing classification of the doorset and comply with the mass of the door. The type of fixings shall not be changed and the number of fixings shall not be reduced Otherwise not possible without an additional test	Additional test double for single and double leaf doorsets or single for single leaf doorsets
C.1.10 Latches/locks	Exchange internal for external	>/=<	Not possible without an additional test	Additional test double for single and double leaf doorsets or single for single leaf doorsets
C.1.11 Latches/locks	Exchange external for internal	>/=<	Not possible without an additional test	Additional test double for single and double leaf doorsets or single for single leaf doorsets

Construction Parameter	Variation	Influence of variation on performance characteristic	Possibility of extension	Additional Evidence Required
(1)	(2)	(3)	(4)	(5)
C.1.13 Face mounted operating device (e.g. handles, knobs, panic bars, push or touch pads)	Remove	=	Possible to remove face mounted components providing the internal lock/latch assembly remains as tested Otherwise not possible without an additional test	Additional test double for single and double leaf doorsets or single for single leaf doorsets
C.1.14 Panic exit device or emergency exit device	Exchange internal for external	>/=<	Not possible without an additional test	Additional test double for single and double leaf doorsets or single for single leaf doorsets
C.1.15 Panic exit device or emergency exit device	Exchange external for internal	>/=<	Not possible without an additional test	Additional test double for single and double leaf doorsets or single for single leaf doorsets
C.1.16 Panic exit device or emergency exit device of the same type	Change of supplier/manufacturer	>/=<	Possible providing the alternative hardware is of the same type (internally mounted/mortised or surface mounted) and complies with its relevant product standard. The classification for category of use, durability of latch action, door mass and closing force according to EN 12209, EN 15685 or EN 14846 shall be in line with the intended durability of self-closing classification of the doorset and comply with the mass of the door. The type of fixings shall not be changed and the number of fixings shall not be reduced Otherwise not possible without an additional test	Additional test double for single and double leaf doorsets or single for single leaf doorsets
C.1.18 Dimension of hinges	Decrease	>/=<	Possible providing the hinge grade based on EN 1935 is in line with the intended durability of self-closing classification of the doorset and complies with the mass of the door. The type of fixings shall not be changed and the number of fixings shall not be reduced Otherwise not possible without an additional test	Additional test single or double leaf doorset
C.1.19 Dimension of dog bolts	Increase	=	Possible	-
C.1.20 Dimension of dog bolts	Decrease	=	Possible	-
C.1.21 Bolts (flush, internal and surface mounted)	Add	=	Possible	-
C.1.22 Bolts (flush, internal and surface mounted)	Remove	=	Possible	-
C.1.23 Bolts (flush, internal and surface mounted)	Alternative	=	Possible	-

Construction Parameter	Variation	Influence of variation on performance characteristic	Possibility of extension	Additional Evidence Required
(1)	(2)	(3)	(4)	(5)
C.1.24 Bolts (flush, internal and surface mounted)	Change of supplier/ manufacturer	=	Possible	-
C.1.25 Number of hinges/dog bolts	Increase	=	Possible	-
C.1.26 Number of hinges/dog bolts	Decrease	=	Not possible without an additional test for hinges Possible for dog bolts	Additional test single or double leaf doorset
C.1.27 Hinges/dog bolts of the same type	Change of supplier/ manufacturer	=	Possible for dog bolts. Possible providing the hinge grade based on EN 1935 is in line with the intended durability of self-closing classification of the doorset and complies with the mass of the door. The type of fixings shall not be changed and the number of fixings shall not be reduce Otherwise not possible without an additional test	Additional test single or double leaf doorset
C.1.28 Type of hinges	Alternative material/type	=	Possible providing the hinge grade based on EN 1935 is in line with the intended durability of self-closing classification of the doorset and complies with the mass of the door. The type of fixings shall not be changed and the number of fixings shall not be reduced Otherwise not possible without an additional test	Additional test single or double leaf doorset
C.1.29 Type of dog bolts	Alternative material/type/ shape	=	Possible	-
C.1.30 Distance from top of upper hinge to top of door	Increase	>/=<	Not possible without an additional test	Additional test single or double leaf doorset
C.1.31 Distance from top of upper hinge to top of door	Decrease	=	Possible	-
C.1.32 Distance from bottom of lower hinge to bottom of door	Increase	>/=<	Not possible without an additional test	Additional test single or double leaf doorset
C.1.33 Distance from bottom of lower hinge to bottom of door	Decrease	=	Possible	-
C.1.34 Distances between top and bottom hinges and intermediate hinges or dog bolts	Increase	=	Possible	-

Construction Parameter	Variation	Influence of variation on performance characteristic	Possibility of extension	Additional Evidence Required
(1)	(2)	(3)	(4)	(5)
C.1.35 Distances between top and bottom hinges and intermediate hinges or dog bolts	Decrease	=	Possible	-
C.1.36 Fixing technique for hinges (door leaf, frame)	Alternative (welding or riveting or screwing)	>/=<	Possible to interchange only between riveting and screwing, providing the centre distances are not exceeded and cross section dimension of the alternative (rivets/screws) is not smaller Otherwise not possible without an additional test Possible to change from screwing or riveting to welding, but not vice versa	Additional test single or double leaf doorset
C.1.37 Armature of an electrically powered separate hold open device	Add	=	Possible	-
C.1.38 Electrically powered hold open device	Exchange original concealed for alternative face mounted	=	Possible	Additional test single or double leaf doorset
C.1.39 Electrically powered hold open device	Exchange original face mounted for alternative concealed	=	Possible	Additional test single or double leaf doorset
C.1.40 Electrically powered hold open device	Change of manufacturer/ alternative	=	Possible	-
C.1.41 Face fixed door closer (face fixed to face fixed, mounted on the closing or opening side of the doorset)	Alternative fitting positions in accordance with table below	=	Possible	-
C.1.42 Face fixed door closer	Alternative	=	Possible providing the door closer power size according to EN 1154 is in accordance with the door size. The type of fixings shall not be changed and the number of fixings shall not be reduced Otherwise not possible without an additional test	Additional test single or double leaf doorset

Construction Parameter	Variation	Influence of variation on performance characteristic	Possibility of extension	Additional Evidence Required
(1)	(2)	(3)	(4)	(5)
C.1.43 Concealed door closer (mounted in the door leaf or the frame)	Alternative	=	Possible providing the door closer power size according to EN 1154 is in accordance with the door size. The type of fixings shall not be changed and the number of fixings shall not be reduced Otherwise not possible without an additional test	Additional test single or double leaf doorset
C.1.44 Concealed door closer	Change of location (door leaf to frame or vice versa)	=	Possible	-
C.1.45 Door closer	Change of location (concealed for face mounted or vice versa)	=	Possible	Additional test single or double leaf doorset
C.1.46 Power cable and protective conduits for electric locks (fitted in the door leaf or frame)	Add	=	Possible	Additional test single or double leaf doorset
C.1.47 Spy holes/key tubes	Add	=	Possible	-
C.1.48 Alarm contacts and proximity switches	Add	=	Possible	-
C.1.49 Alarm contacts and proximity switches	Alternative	=	Possible	-
C.1.50 Door signs (Euroclass A1)	Add	=	Possible	-
C.1.51 Door signs (< Euroclass A1)	Add	=	Possible	-
C.1.52 Pivots with single action accessories (shoe & top centre) with or without floor/transom mounted closing devices	Exchange from hinges	>/=<	Not possible without an additional test	Additional test single or double leaf doorset
C.1.53 Pivots with single action accessories (shoe & top centre) with or without floor/transom mounted closing devices	Exchange to hinges	>/=<	Not possible without an additional test	Additional test single or double leaf doorset
C.1.54 Door closer	Change of supplier manufacturer	=	Possible providing the door closer is according to EN 1154 Otherwise not possible without an additional test	Additional test single or double leaf doorset
C.1.55 Door coordinator device	Change of supplier manufacturer	=	Possible providing the door closer is according to EN 1158 Otherwise not possible without an additional test	Additional test double leaf doorset
C.1.56 Door coordinator device	Alternative fitting position	>/=<	Possible providing the coordinator device on the alternative fitting position is from the same type and the same accessories (e.g. carry bars) are used Otherwise not possible without an additional test	Additional full scale test shall be double leaf doorset

Construction Parameter	Variation	Influence of variation on performance characteristic	Possibility of extension	Additional Evidence Required
(1)	(2)	(3)	(4)	(5)
D. Support/attachment - door leaf to framing				
D.1. General				
D1.1. Gap dimensions (door leaf to frame)	Increase/decrease	=	Possible in line with direct application in accordance with EN 1634-1 beyond the field of direct application rules Not possible without an additional test	Additional test double for single and double leaf door sets or single for single leaf door sets
E. Transom panels and flush over panels				
Transom panels/flush over panels and their variations have no negative impact on self-closing ability.				
E.1. Side, over and transom panel arrangements				
E.1.1 Transom panel arrangement	Add	=	Possible	Additional test single or double leaf doorset
E.1.2 Side/flush over panel arrangement	Add	=	Possible	-
E.1.5 Cut outs in panels (penetration)	Add	=	Possible	-
E.2. General				
Parameter variations as defined in A.1 have no negative impact on self-closing ability				
E.3. Size variations				
E.3.1 Size (area, width, height) - all distortions	Decrease	=	Possible	-
E.3.2 Size (area, width, height) - all distortions	Increase	=	Possible	Test the largest doorset
E.3.3 Thickness of the panel (excluding glazing covered in Clause F)	Increase	=	Possible	-
E.3.4 Thickness of the panel (excluding glazing covered in Section F)	Decrease	=	Possible	-
E.4. Materials and construction				
Parameter variations as defined in A.3 have no negative impact on self-closing ability				
E.4.2 Type of steel sheet	Mild to stainless	=	Possible	-
E.4.3 Type of steel sheet	Stainless to mild	=	Possible	-
E.5 Decorative and/or protective finishes				
Parameter variations as defined in A.4 have no negative impact on self-closing ability				

Construction Parameter	Variation	Influence of variation on performance characteristic	Possibility of extension	Additional Evidence Required
(1)	(2)	(3)	(4)	(5)
F. Glazing for door leaf/leaves or side/transom and flush over panels				
F. 1 General				
Where „similar edge fixing technique” is referred to, this means that the technique used in the original door test should be replicated exactly in terms of the retention detail or that the technique may be modified to accommodate a technique proven in an alternative test.				
F.1.1 Glazed aperture	Add	>/=/<	Not possible without an additional test	Additional full scale test can be single or double leaf doorset
F.1.2 Glazed aperture	Remove	=	Possible	-
F.1.3 Glazed aperture	Transposition between leaves	=	Possible providing the requirements of Annex B are fulfilled Otherwise not possible without an additional test	Additional test single or double leaf doorset
F.1.4 Glazed aperture	Size variation between smallest and largest tested glazed aperture	=	See F.1.7 and F.1.8	-
F.1.5 Thickness of glass	Increase	=	Possible providing the requirements of Annex B are fulfilled Otherwise not possible without an additional test	Additional test single or double leaf doorset
F.1.6 Thickness of glass	Decrease	=	Possible providing a similar edge fixing technique only modified to accommodate the alternative thickness Otherwise not possible without an additional test	Additional test single or double leaf doorset
F.1.7 Dimensions of each glazed aperture	Increase	=	Possible providing the requirements of Annex B are fulfilled Otherwise not possible without an additional test	Additional test single or double leaf doorset
F.1.8 Dimensions of each glazed aperture	Decrease	=	Possible	-
F.1.9 Type of glass	Change of glass type	=	Possible providing the requirements of Annex B are fulfilled Otherwise not possible without an additional test	Additional test single or double leaf doorset
F.1.10 Materials and geometry of edge fixing technique (with the same glass type)	Alternative	=	Possible	-
F.1.11 Decorative capping	Add or exchange	=	Possible	-
F.1.12 Type and number of edge fixings (e.g. clips, screws, rivets)	Alternative	=	Possible	-

Construction Parameter	Variation	Influence of variation on performance characteristic	Possibility of extension	Additional Evidence Required
(1)	(2)	(3)	(4)	(5)
F.1.13 Shape of glazing	Interchange between rectangular and round	=	Possible	-
F.1.14 Number of glazed apertures	Increase	=	Possible	-
F.1.15 Number of glazed apertures	Decrease	=	Possible	-
F.1.16 Smallest tested distance between the edge of glazing and the perimeter of the door leaf/panel	Increase	=	Possible	-
F.1.18 Distance between glazed apertures	Increase	=	Possible	-
F.1.19 Distance between glazed apertures	Decrease	=	Possible	-
G Supporting construction and attachment (technique) of door frame or side/transom panels/flush over panels				
G.1 General				
G.1.3 Supporting construction	Standard to associated and vice versa	>/=/<	Not possible without an additional test	Additional test double for single and double leaf doorsets or single for single leaf doorsets
G.1.4 Attachment technique	Alternative built-in frame anchor to plug & screw and vice versa	>/=/<	Possible providing the fixings are appropriate to the construction and the distance between the fixings is not increased Otherwise not possible without an additional test	Additional test double for single and double leaf doorsets or single for single leaf doorsets
G.1.5 Type of fixings	Alternative manufacturer/supplier	=	Possible	-
G.1.6 Type of fixings	Alternative material	=	Possible to interchange between alternative fixing material providing the same or higher mechanical performance Otherwise not possible without an additional test	Additional full scale test can be single or double leaf doorset
G.1.7 Number and/or size of fixings	Increase	>	Possible	-
G.1.8 Number and/or size of fixings	Decrease	<	Not possible without an additional test	Additional full scale test can be single or double leaf doorset with or without a panel in the same type of supporting construction

Construction Parameter	Variation	Influence of variation on performance characteristic	Possibility of extension	Additional Evidence Required
(1)	(2)	(3)	(4)	(5)
G.1.10 Distance between fixings	Decrease	=	Possible	-
G.1.11 Fixing to floor	Cleated to sunk	=	Possible	-
G.1.12 Fixing to floor	Sunk to cleated	=	Possible	-
G.1.13 Gap between door leaf and floor	Increase	=	Possible	-
G.1.14 Gap between door leaf and floor	Decrease	=	Possible	-
G.2 Modified supporting construction				
G.2.1 Standard flexible supporting construction	Strengthened to accommodate fixing requirements	=	Possible	-
G.3 Associated supporting construction				
Key to symbols in column 3 > higher performance anticipated < lower performance anticipated = no significant change in performance anticipated ≥ equal or higher performance anticipated ≤ equal or lower performance anticipated >=/< the influence on performance could be worse, equal or better hence variations not possible unless specific, limited conditions are identified N.A. Not Applicable				

Construction parameter variation simulation by applying additional weights

Variations (Table A) will be possible providing that the total mass (weight) of the door leaf caused by the variation will not be increased. The test specimen for durability test of self-closing can be loaded with additional weights attached to the door leaf surface to simulate the higher mass (weight) of the varied door under the following conditions:

Any additional weights are to be mounted equally on the outside and inside of the infilled panel so that the centre of gravity and mass replicate the varied door. For double leaf doorsets the rule has to be applied appropriately.