

RØRKANALER

til klimaanlæg og varmepumper

- STANDARD
- TILBEHØR TIL RØRKANALER
- TILBEHØR TIL FASTGØRELSE

OPTIMA





DET MAGISKE NUMMER 43 24 17 17

AHLSSELLS KUNDESERVICE

Vores kundeservice leverer service på højt niveau. Når du ringer på 43 24 17 17, så kommer du direkte igennem til vores kundeservice, hvor vores dygtige team sidder klar til at hjælpe dig.

Har du spørgsmål af teknisk karakter, så vil teamet hurtigt kunne finde den rigtige medarbejder, som kan hjælpe dig videre.

Kundeservice kan bl.a. hjælpe dig med:

- Ordre, inkl. forespørgsler på ordre og webshopordre
- Reklamationer
- Forespørgsler på brochurer og andet teknisk information
- Oprettelse til webshop
- Oprettelse som ny kunde, samt status på evt. oprettelse
- Forespørgsler på forsendelsestid
- Lagerbeholdning
- Rettelser og tilføjelser til din kundekonto, adresser, mail, telefonnr. m.m.

Kort sagt: Kundeservice er vores centrallinie, som hurtigt sætter dig i forbindelse med den rigtige kollega, hvis de ikke selv kan klare opgaven.

**RÅMATERIALE:
STØD- OG UVA-RESISTENT
HÅRD PVC**



**EKSTERN FINISH
I HØJ KVALITET**

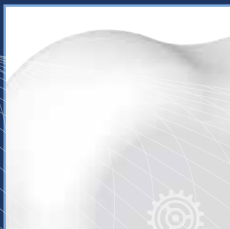

**FOKUS PÅ DESIGN
HØJ FUNKTIONALITET
DETALJER**



**TILBEHØR I NYT DESIGN
FUNKTION OG ELEGANCE**



**TILBEHØR
KLIKKES SAMMEN**



**BASE MED TO
FORBOREDE HULLER
TIL FASTGØRELSE PÅ VÆG**



**PATENTERET LÅSEM-
EKANISME MELLEM LÅG
OG KANAL**



**AFRUNDET DÆKSEL
OG
SKARPKANTET BASE**



OPTIMA T -Serien RØRKANALER

TEKNISKE FUNKTIONER

- STØD- OG UVA-RESISTENT HÅRD PVC I HVID
- SKARPKANTET BASE MED FORBOREDE HULLER TIL FASTGØRELSE TIL VÆGGEN
- DESIGNET TIL AT PASSE TIL EASY FLOW-MINIPUMPE (KUN STØRRELSE 75)
- PATENTERET LÅSEMEKANISME MELLEM LÅG OG KANAL
- AFRUNDET DÆKSEL

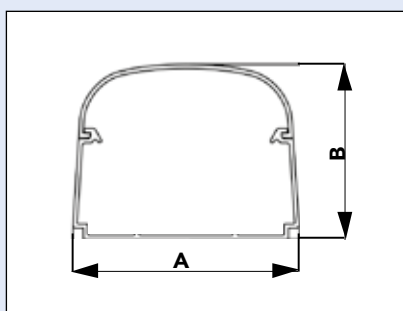

ANVENDELSESFORMÅL



RØRKANALER T62-OPT
Velegnet til installation af mono-splitenheder

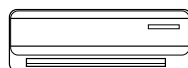
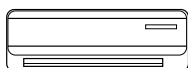

RØRKANALER T75 - OPT
Velegnet til installation af mono- og dobbelt-splitenheder

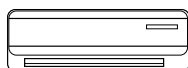
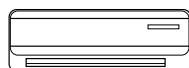
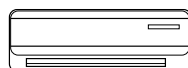
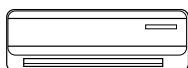

RØRKANALER T102- OPT
Velegnet til installation af dobbelt- og tredobbelt-splitenheder

MODEL	KODE	DIMENSIONER		VARENUMMER
		A (mm)	B (mm)	
T 62 - OPT	11130062	62	46	-
T 75 - OPT	11130075	74	56	26111012
T 102 - OPT	11130100	100	66	26111014

OPTIMA TM -Serien til VÆG

TEKNISKE FUNKTIONER

- NY, MILJØVENLIG STØD- OG UVA-RESISTENT PVC I HVID
- INNOVATIVT DESIGN
- FASTGØRELSESSYSTEM, DER ER ULTRAHURTIGT AT KLIKKE SAMMEN
- 3 X FORBOREDE HULLER TIL DRÆNLEDNINGENS UDGANG
- 3 X FORBOREDE HULLER TIL MULIG FASTGØRELSE TIL VÆGGEN
- EKSTERN FINISH I HØJ KVALITET

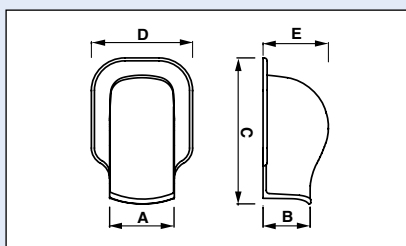

TM 62 - OPT

TM 75 - OPT

TM 102 - OPT



MODEL	KODE	DIMENSIONER					VARENUMMER
		A (mm)	B (mm)	C (mm)	D mm	E mm	
TM 62 - OPT	11106001	66	48	155	95	60	Skaffevare
TM 75 - OPT	11106002	78	58	175	115	71	26111064
TM 102 - OPT	11106003	104	68	200	135	82	26111066

OPTIMA TA -Serien HJØRNEDÆKSEL

TEKNISKE FUNKTIONER

- MILJØVENLIG STØD- OG UVA-RESISTENT PVC I HVID
- INNOVATIVT DESIGN
- FASTGØRELSESSYSTEM, DER ER ULTRAHURTIGT AT KLIKKE SAMMEN
- STOR YDRE DÆKSELFLANGE
- EKSTERN FINISH I HØJ KVALITET

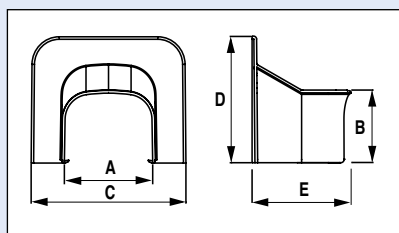

TA 62 - OPT

TA 75 - OPT

TA 102 - OPT



MODEL	KODE	DIMENSIONER					varenummer
		A (mm)	B (mm)	C (mm)	D mm	E mm	
TA 62 - OPT	11106004	90	48	116	88	70	Skaffevare
TA 75 - OPT	11106005	78	58	126	100	85	26111058
TA 102 - OPT	11106006	104	68	146	118	100	26111060

OPTIMA CP -Serien FLADT VINKELSTYKKE

TEKNISKE FUNKTIONER

- NY, MILJØVENLIG STØD- OG UVA-RESISTENT PVC I HVID
- INNOVATIVT DESIGN
- FASTGØRELSESYSTEM, DER ER ULTRAHURTIGT AT KLIKKESAMMEN
- EKSTERN FINISH I HØJ KVALITET

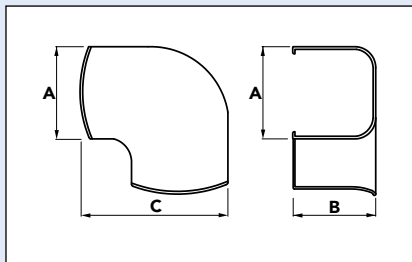

CP 62 - OPT

CP 75 - OPT

CP 102 - OPT



MODEL	KODE	DIMENSIONER			VARENUMMER
		A (mm)	B (mm)	C (mm)	
CP 62 - OPT	11106007	66	48	108	Skaffevare
CP 75 - OPT	11106008	78	58	120	26111030
CP 102 - OPT	11106009	104	68	145	26111032

OPTIMA CPS -Serien FLADT, SAMMENFØJET VINKELSTYKKE

TEKNISKE FUNKTIONER

- NY, MILJØVENLIG STØD- OG UVA-RESISTENT PVC I HVID
- INNOVATIVT DESIGN
- FASTGØRELSESYSTEM, DER ER ULTRAHURTIGT AT KLIKKESAMMEN
- JUSTERBAR RADIUS PÅ RUNDING 80 °-140 °
- EKSTERN FINISH I HØJ KVALITET

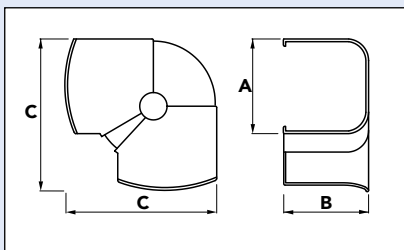

MODEL	KODE	DIMENSIONER			VARENUMMER
		A (mm)	B (mm)	C (mm)	
CPS 62 - OPT	11106010	67	48	115	Skaffevare
CPS 75 - OPT	11106011	79	58	130	26111036

OPTIMA CAI -Serien HJØRNE INDE I VINKELSTYKKE

TEKNISKE FUNKTIONER

- NY, MILJØVENLIG STØD- OG UVA-RESISTENT PVC I HVID
- INNOVATIVT DESIGN
- FASTGØRELSESYSTEM, DER ER ULTRAHURTIGT
- AT KLIKKE SAMMEN
- EKSTERN FINISH I HØJ KVALITET
- FOR RØR MED STOR RADIUS FOR RUNDING

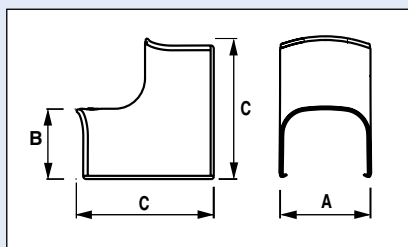

MODEL	KODE	DIMENSIONER			VARENUMMER
		A (mm)	B (mm)	C (mm)	
CAI 62 - OPT	11106013	66	48	105	Skaffevare
CAI 75 - OPT	11106014	78	57	115	26111046
CAI 102 - OPT	11106015	104	68	125	26111048

OPTIMA CAE -Serien HJØRNE UDEN FOR VINKELSTYKKE

TEKNISKE FUNKTIONER

- NY, MILJØVENLIG STØD- OG UVA-RESISTENT PVC I HVID
- INNOVATIVT DESIGN
- FASTGØRELSESYSTEM, DER ER ULTRAHURTIGT AT KLIKKE SAMMEN
- EKSTERN FINISH I HØJ KVALITET
- FOR RØR MED STOR RADIUS FOR RUNDING

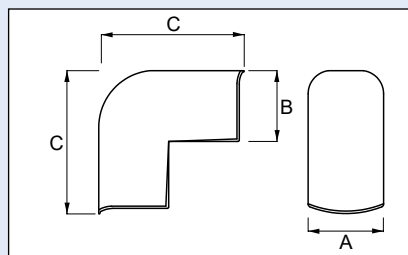

MODEL	KODE	DIMENSIONER			VARENUMMER
		A (mm)	B (mm)	C (mm)	
CAE 62 - OPT	11106019	66	48	100	Skaffevare
CAE 75 - OPT	11106020	78	58	115	26111052
CAE 102 - OPT	11106021	104	68	135	26111054

OPTIMA MG - serie SAMLEMUFFE

TEKNISKE FUNKTIONER

- NY, MILJØVENLIG STØD- OG UVA-RESISTENT PVC I HVID
- INNOVATIVT DESIGN
- FASTGØRELSESYSTEM, DER ER ULTRAHURTIGT AT KLIKKE SAMMEN
- EKSTERN FINISH I HØJ KVALITET

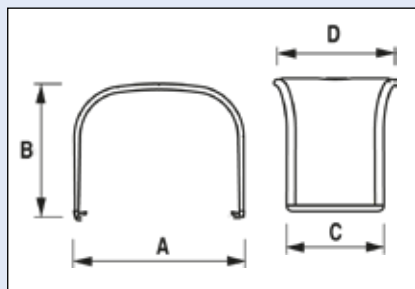

MG 62 - OPT

MG 75 - OPT

MG 102 - OPT



MODEL	KODE	DIMENSIONER				VARENUMMER
		A (mm)	B (mm)	C (mm)	D mm	
MG 62 - OPT	11106028	66	48	40	50	Skaffevare
MG 75 - OPT	11106029	78	58	45	55	26111086
MG 102 - OPT	11106027	104	68	50	70	26111088

OPTIMA DT -Serien T-STYKKE

TEKNISKE FUNKTIONER

- NY, MILJØVENLIG STØD- OG UVA-RESISTENT PVC I HVID
- INNOVATIVT DESIGN
- FASTGØRELSESYSTEM, DER ER ULTRAHURTIGT AT KLIKKE SAMMEN
- EKSTERN FINISH I HØJ KVALITET
- KAN RUMME RØR MED STOR RADIUS FOR RUNDING

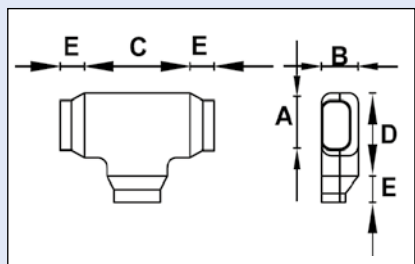

SÆTTET INDEHOLDER:

- DT 62 - OPT INDEHOLDENDE DT75-OPT OG TO REDUKTIONSMUFFER TIL STØRRELSE 62 RØRKANALER
- DT 75 - OPT OMFATTENDE ET T-STYKKE STØRRELSE 75
- DT 102 - OPT OMFATTENDE ET T-STYKKE STØRRELSE 102

MODEL	KODE	DIMENSIONER					VARENUMMER
		A (mm)	B (mm)	C (mm)	D mm	E mm	
DT 62 - OPT	11106031	66	48	180	130	60	Skaffevare
DT 75 - OPT	11106032	78	58	180	130	-	26111040
DT 102 - OPT	11106033	104	68	210	160	-	26111042

OPTIMA TS -Serien ENDEBESLAG TIL RØRUDLØB

TEKNISKE FUNKTIONER

- NY, MILJØVENLIG STØD- OG UVA-RESISTENT PVC I HVID
- INNOVATIVT DESIGN
- FASTGØRELSESYSTEM, DER ER ULTRAHURTIGT AT KLIKKE SAMMEN
- EKSTERN FINISH I HØJ KVALITET

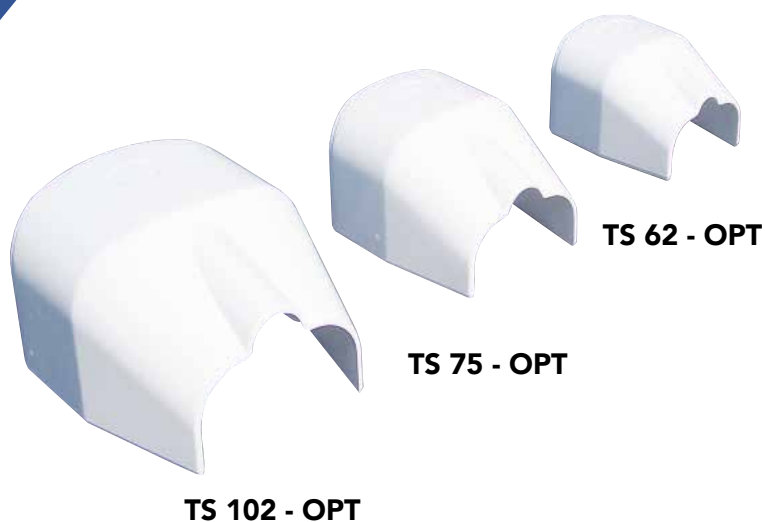
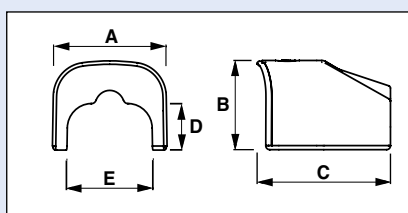

MODEL	KODE	DIMENSIONER					VARENUMMER
		A (mm)	B (mm)	C (mm)	D mm	E mm	
TS 62 - OPT	11106035	66	48	76	30	50	Skaffevarer
TS 75 - OPT	11106036	78	58	90	30	56	26111070
TS 102 - OPT	11106037	104	68	110	40	72	26111078

OPTIMA TC -Serien SLUTMUFFE

TEKNISKE FUNKTIONER

- NY, MILJØVENLIG STØD- OG UVA-RESISTENT PVC I HVID
- INNOVATIVT DESIGN
- FASTGØRELSESYSTEM, DER ER ULTRAHURTIGT AT KLIKKE SAMMEN
- EKSTERN FINISH I HØJ KVALITET

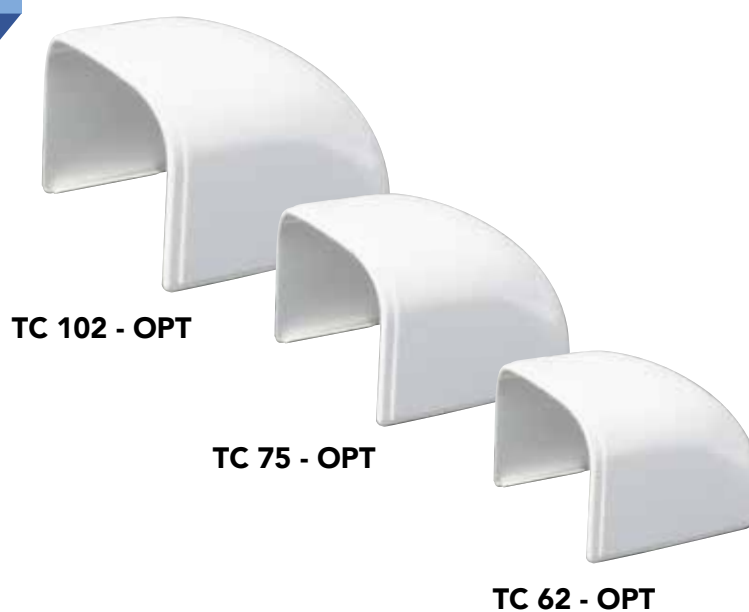
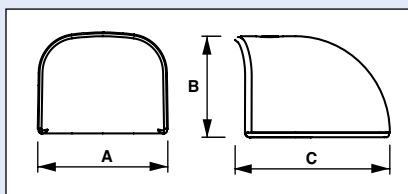

MODEL	KODE	DIMENSIONER			VARENUMMER
		A (mm)	B (mm)	C (mm)	
TC 62 - OPT	11106038	66	48	75	Skaffevarer
TC 75 - OPT	11106039	78	58	90	26111070
TC 102 - OPT	11106040	104	68	105	26111072

OPTIMA MF -Serien FLEKKANAL

TEKNISKE FUNKTIONER

- NY, MILJØVENLIG STØD- OG UVA-RESISTENT PVC I HVID
- INNOVATIVT DESIGN
- FASTGØRELSESYSTEM, DER ER ULTRAHURTIGT AT KLIKKE SAMMEN
- EKSTERN FINISH I HØJ KVALITET

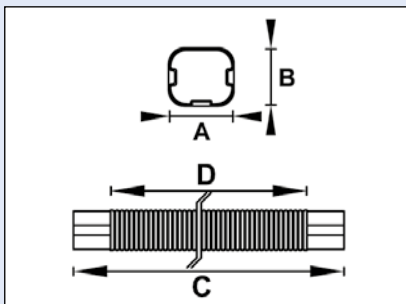

MF 102 - OPT MF 75 - OPT MF 62 - OPT



MODEL	KODE	DIMENSIONER				VARENUMMER
		A (mm)	B (mm)	C (mm)	D mm	
MF 62 - OPT	11106041	62	46	520	420	Skaffevare
MF 75 - OPT	11106042	74	56	520	420	26111092
MF 102 - OPT	11106043	100	66	520	420	26111094

REDUKTIONSMUFFE TIL OPTIMA RC -serien

TEKNISKE FUNKTIONER

- NY, MILJØVENLIG STØD- OG UVA-RESISTENT PVC I HVID
- INNOVATIVT DESIGN
- FASTGØRELSESYSTEM, DER ER ULTRAHURTIGT AT KLIKKE SAMMEN
- EKSTERN FINISH I HØJ KVALITET

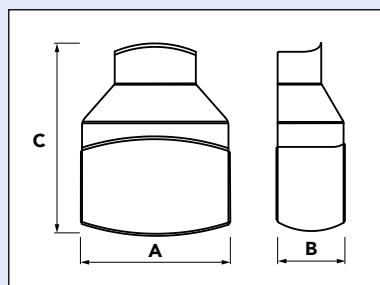

MODEL	KODE	DIMENSIONER			Varenummer
		A (mm)	B (mm)	C (mm)	
RC 75/62 - OPT	11106034	79	66	80	Skaffevare
RC 102/75 - OPT	11106044	105	78	108	26112000

TILBEHØR TIL RØRKANALER



KONDENSING UNIT CO2



QUIET CO2OL

Den nye CO2 kondensering unit QUIET CO2OL fra Profroid er en konkurrencedygtig CO2-løsning.

De valgte komponenter i QUIET CO2OL er af høj kvalitet, der blandt andet indeholder Inverter af variable kølebehov.

Kontakt din kontaktperson hos Ahlsell for yderligere information.

6 MODELLER:

0,7 - 9,2 kW

Et bæredygtigt valg

Et naturligt valg

Stabil drift

PROFROID

ahlsell

ahlsell



AHLSSELL DANMARK APS



Brøndby:
Abilager 24
2605 Brøndby



Aarhus:
Samuel Morses Vej 3
8200 Aarhus



Kolding:
Platinvej 57
6000 Kolding



Aalborg:
Virkelyst 25
9400 Nørresundby



Tlf: 43241717



www.ahlsell.dk



ahlsellref@ahlsell.dk

*Vi forbeholder os ret til at ændre design, priser og specifikationer uden forudgående varsel.
Forbehold for evt. trykfejl. Vi henviser til generelle salgs- og leveringsbetingelser.*